



Administrator's Guide for the VSX Series

Version 9.0.6

March 2010 Edition
3725-20235-013/A
Version 9.0.6



Trademark Information

© 2010, Polycom, Inc. All rights reserved. POLYCOM®, the Polycom “Triangles” logo and the names and marks associated with Polycom’s products are trademarks and/or service marks of Polycom, Inc. and are registered and/or common law marks in the United States and various other countries. All other trademarks are property of their respective owners. No portion hereof may be reproduced or transmitted in any form or by any means, for any purpose other than the recipient’s personal use, without the express written permission of Polycom.

Patent Information

The accompanying product is protected by one or more U.S. and foreign patents and/or pending patent applications held by Polycom, Inc.

© 2010 Polycom, Inc. All rights reserved.

Polycom Inc.
4750 Willow Road
Pleasanton, CA 94588-2708
USA

No part of this document may be reproduced or transmitted in any form or by any means, electronic or mechanical, for any purpose, without the express written permission of Polycom, Inc. Under the law, reproducing includes translating into another language or format.

As between the parties, Polycom, Inc. retains title to, and ownership of, all proprietary rights with respect to the software contained within its products. The software is protected by United States copyright laws and international treaty provision. Therefore, you must treat the software like any other copyrighted material (e.g. a book or sound recording).

Every effort has been made to ensure that the information in this manual is accurate. Polycom, Inc. is not responsible for printing or clerical errors. Information in this document is subject to change without notice.

About This Guide

The *Administrator's Guide for the VSX Series* is for administrators who need to configure, customize, manage, and troubleshoot VSX™ systems. The guide covers the VSX 3000, VSX 3000A, VSX 5000, VSX 6000, VSX 6000A, VSX 7000, VSX 7000s, VSX 7000e, and VSX 8000 systems.

Please read the VSX system documentation before you install or operate the system. The following related documents for VSX systems are available at www.polycom.com/videodocumentation:

- *Setting Up the System*, which describes how to set up the hardware
- *Getting Started Guide for the VSX Series*, which describes how to perform video conferencing tasks
- Setup Sheets for your optional hardware
- Release Notes
- *Integrator's Reference Manual for the VSX Series*, which provides cable information and API command descriptions

For support or service, please contact your Polycom distributor or go to Polycom Support at www.polycom.com/support.

Polycom recommends that you record the serial number and option key of your VSX system here for future reference. The serial number for the system is printed on the unit.

System Serial Number: _____

Option Key: _____

Contents

1 Introducing the VSX Series 1-1

VSX Models	1-1
VSX 3000 and VSX 3000A Desktop Systems	1-1
VSX 5000 Set-top System	1-1
VSX 6000 and VSX 6000A Set-top Systems	1-2
VSX 7000 and VSX 7000s Set-top Systems	1-2
VSX 7000e Component System	1-2
VSX 8000 Component System	1-2
Setting Up Your System Hardware	1-2
Positioning the System	1-2
Positioning Desktop Systems	1-3
Positioning Set-top Systems	1-3
Positioning Component Systems	1-4
Powering On the System	1-5
Powering On the VSX 3000 or VSX 3000A Desktop System	1-6
Powering On Set-top and Component Systems	1-6
Configuring with the Setup Wizard	1-6

2 Networks 2-1

Getting the Network Ready	2-1
Connecting to the LAN	2-1
Configuring LAN Properties	2-2
Configuring IP Settings	2-4
Specifying H.323 Settings	2-4
Configuring the System to Use a Gatekeeper	2-4
Configuring Integration with Avaya Networks	2-7
Configuring the System to Use a Gateway	2-8
Specifying SIP Settings	2-9
Integration with Microsoft Live Communications Server (LCS)	2-10
Adding and Removing Microsoft LCS Contacts	2-11
Specifying Quality of Service	2-12
Configuring the System for Use with a Firewall or NAT	2-13
Firewall Settings	2-13
H.460 NAT Firewall Traversal	2-15

Connecting to ISDN or Other Networks	2-16
Connecting Desktop Systems to the ISDN BRI Network	2-17
Connecting Set-top and Component Systems to ISDN or Other Networks	2-18
Quad BRI Network Interface Status Lights	2-19
PRI Network Interface Status Lights	2-20
Serial V.35/RS-449/RS-530 Network Interface Status Lights	2-20
Configuring ISDN and Other Network Interface Settings	2-20
Configuring the BRI Network Interface	2-21
Configuring the PRI Network Interface	2-22
Configuring the Serial V.35/RS-449/RS-530 Network Interface	2-25
Connecting to a Phone Line	2-28
Configuring Telephony	2-28
Configuring Call Preferences	2-29
Configuring Dialing Order Settings	2-31

3 Monitors and Cameras 3-1

Connecting Monitors	3-1
Using a Desktop System as the Monitor for a Computer	3-1
Configuring Monitor Settings	3-2
Using Dual Monitor Emulation	3-7
Examples of Dual Monitor Emulation	3-7
Using Dual Monitor Emulation in a Call	3-7
Configuring Multipoint Viewing Modes	3-8
Adjusting the Monitor's Color Balance, Sharpness, and Brightness	3-9
Preventing Monitor Burn-In	3-10
Connecting Cameras	3-11
Connecting Document Cameras to Desktop Systems	3-11
Connecting Cameras to Set-top Systems	3-11
Connecting Cameras to Component Systems	3-11
Configuring Camera Settings and Video Quality Options	3-12
Configuring Automatic Camera Tracking	3-14
Configuring Camera Presets	3-15

4 Microphones and Speakers 4-1

Connecting Polycom Microphones or a SoundStation VTX 1000	4-1
Connecting Polycom Microphones to Set-Top or Component Systems	4-1
Placing Polycom Microphones to Send Stereo from Your Site	4-3
Connecting a SoundStation VTX 1000 to a Set-top or Component System	4-4
Placing a SoundStation VTX 1000 Phone to Send Stereo from Your Site	4-5
Connecting Non-Polycom Microphones to a Set-top System	4-6
Connecting Non-Polycom Microphones or a Mixer	4-6

Connecting Speakers	4-6
Connecting Speakers or Headphones to Desktop Systems	4-6
Connecting Speakers to Set-top Systems	4-6
Connecting Speakers to Component Systems	4-7
Placing Speakers to Play Stereo from Far Sites	4-7
Setting the Speaker Volume	4-8
Configuring Audio Settings	4-9
General Audio Settings	4-9
StereoSurround Settings	4-14
Settings for Connecting to a Polycom Vortex Mixer	4-15
Settings for Non-Polycom Microphones	4-16
Settings for Microphones Connected to Balanced Audio Inputs on a VSX 8000 System	4-16
5 Content and Closed Captions	5-1
Connecting VCR/DVD	5-1
Configuring VCR/DVD Player Settings	5-2
Playing a Videotape or DVD	5-2
Recording a Call to Videotape or DVD	5-2
Connecting a Visual Concert VSX to Set-top Systems	5-3
Connecting an ImageShare II to Component Systems	5-5
Connecting Computers to Component Systems	5-5
Configuring Content Display with a Visual Concert VSX or ImageShare II	5-6
Configuring Content Display with People+Content IP	5-7
Configuring Closed Captioning	5-9
Via a Dial-Up Connection to the Systems' RS-232 Serial Port	5-9
Via the System's Serial RS-232 Port	5-10
Via the System's Web Interface	5-11
Via a Telnet Session	5-12
6 Calling and Answering	6-1
Configuring Call Settings	6-1
Setting the Call Answering Mode	6-3
Configuring Multipoint Calling	6-3
Entering a Multipoint Option Key	6-4
Configuring with PathNavigator's Conference on Demand Feature	6-4
Including More Than Three Other Sites in a Cascaded Call	6-5
Configuring Directory Settings	6-6
Creating a Localized System Name with the System's Web Interface	6-6
Managing Directories with the System's Web Interface	6-7
Configuring the Global Directory	6-8
Setting the Dialing Rules	6-9
Configuring Streaming Calls	6-9

7 System Location, Appearance, and Tones 7-1

Setting Date, Time, and Location	7-1
Designing the Home Screen	7-3
Customizing the Home Screen	7-3
Displaying Contacts on the Home Screen	7-6
Adding Marquee Text	7-6
Changing System Appearance	7-7
Applying The Video Overlay	7-8
Setting Ring Tones and Alert Tones	7-9
Customizing Camera Names and Icons	7-9
Screen Savers	7-10
Adding Screen Saver Text	7-10
Adding a Screen Saver News Feed	7-10
Adding a Screen Saver Logo	7-11
Changing the Screen Saver Wait Time	7-11

8 Security 8-1

Screens that Require the Room Password for Access	8-1
Configuring Security Options	8-2
Setting the Room and Remote Access Passwords	8-4
Managing User Access to Settings and Features	8-5
Configuring Security Mode	8-6
Enabling AES Encryption	8-7

9 Managing the System Remotely 9-1

Using the System's Web Interface	9-1
Accessing the System's Web Interface	9-1
Monitoring a Room or Call with the System's Web Interface	9-2
Managing System Profiles with the System's Web Interface	9-3
Sending a Message	9-4
Configuring Global Services	9-4
Viewing the Management Servers List	9-4
Requiring an Account Number for Calls	9-5
Adding Information for the Global Management System Administrator	9-5
Requesting Technical Support from the Global Management System Administrator	9-6
Setting Up SNMP	9-6
Downloading MIBs	9-7
Configuring for SNMP Management	9-7
Keeping Your Software Current	9-8

10 Control Devices	10-1
Configuring Remote Control Behavior	10-1
Connecting Control and Accessibility Equipment	10-2
Connecting Touch-Panel Controls	10-2
Connecting IR Sensors to VSX 8000 Systems	10-2
Configuring RS-232 Serial Port Settings	10-3
11 Statistics and Diagnostics	11-1
Diagnostic Screens	11-1
System Status	11-2
Call Statistics	11-3
Network	11-4
Video	11-4
Audio	11-5
Restart System	11-5
Recent Calls	11-6
Call Detail Report (CDR)	11-6
Information in the CDR	11-7
Call Detail Report Archives	11-10
12 Troubleshooting	12-1
Placing a Test Call	12-1
Enabling Basic Mode	12-2
General Troubleshooting	12-2
Power and Start-up	12-3
Controls	12-4
Access to Screens and Systems	12-6
Calling	12-8
Displays	12-12
Cameras	12-17
Audio	12-19
Error Indications	12-24
How to Contact Technical Support	12-25
A System Back Panel Views	A-1
VSX 3000 and VSX 3000A Connector Panel	A-1
VSX 5000 Back Panel	A-2
VSX 6000 Back Panel	A-3
VSX 6000A Back Panel	A-4
VSX 7000 Back Panel	A-5
VSX 7000s Back Panel	A-6
VSX 7000e Back Panel	A-7
VSX 8000 Back Panel	A-8

B	Video Source Output Examples for Multiple Monitors B-1
C	Port Usage C-1
D	PathNavigator Error Codes and Q.850 Cause Codes D-1
	PathNavigator Error Codes D-1
	Q.850 Cause Codes D-4
E	Multipoint Dialing Speed E-1
	Regulatory Notices Regulatory Notices-1
	Index Index-1

Introducing the VSX Series

Your Polycom® video conferencing system is a state-of-the-art visual collaboration tool. With crisp, clean video and crystal-clear sound, your VSX system provides natural video conferencing interaction through the most advanced video communications technology.

VSX Models

For technical specifications and detailed descriptions of features available for VSX models, please refer to the product literature available at www.polycom.com.

This guide covers instructions for the following models.

VSX set-top systems	VSX component systems	VSX desktop systems
		

VSX 3000 and VSX 3000A Desktop Systems



The VSX 3000 and VSX 3000A systems deliver high-quality, video communication in an all-in-one appliance that includes the camera, LCD screen, speakers, and microphone. Two models of VSX 3000 and VSX 3000A are available: IP only, and IP with ISDN. Save space in your office by using the VGA cable to connect your computer to the system's 17" high-resolution XGA display.

VSX 5000 Set-top System



The VSX 5000 is a compact, entry-level system with an all-electronic, built-in camera.

VSX 6000 and VSX 6000A Set-top Systems



The VSX 6000 system is an entry-level video conferencing system for IP and SIP networks only. The VSX 6000A additionally provides a Quad BRI option for ISDN.

VSX 7000 and VSX 7000s Set-top Systems



The VSX 7000 and VSX 7000s systems provide cutting-edge video conferencing technology for IP and other networks. The subwoofer provides additional depth to the sound, creating a high-quality sonic space comparable to a home theater system.

VSX 7000e Component System



The VSX 7000e is a video component system for medium-sized conferencing rooms.

VSX 8000 Component System



The VSX 8000 system is a compact component system for custom integration.

Setting Up Your System Hardware

This manual provides information to supplement the setup sheets provided with your system and its optional components. A printed copy of the system setup sheet is provided with each VSX system. PDF versions of the system setup sheets are available at www.polycom.com/videodocumentation.

Positioning the System

Position the system so that the camera does not face toward a window or other source of bright light. Place the camera and display together so that people at your site face the camera when they face the far-site display.



Positioning Desktop Systems

The VSX 3000 and VSX 3000A systems are personal video conferencing systems for the desktop.

To position the system:

- Place the VSX 3000 or VSX 3000A system on your desktop or on a table in a small conference room, leaving enough space so that you can connect the cables easily.

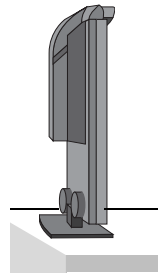

If you need to place the system face-down to connect the cables, make sure that the camera does not touch the work surface. The weight of the system can damage the camera mount.

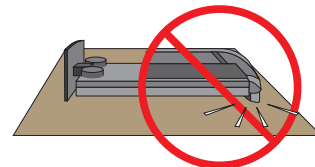
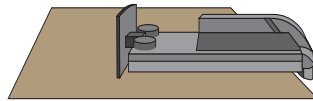

Positioning Set-top Systems

The VSX 5000, VSX 6000, VSX 6000A, VSX 7000, and VSX 7000s systems are designed to be placed on top of a monitor. You can order a shelf that can be mounted on a wall or placed on top of a flat-panel monitor.

To position the system:

1. The hardware kit you received with the system includes a pair of self-adhesive feet. If the monitor's chassis slopes back sharply, install the feet on the bottom of the system to stabilize it.

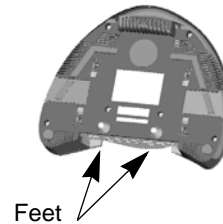

2. Place the system in the desired location, with the rounded front portion hanging over the front of the monitor or shelf. Leave enough space to work, so that you can connect the cables easily.

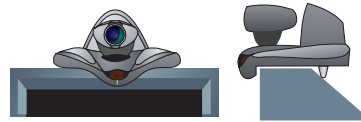

3. Remove the packaging collar from around the VSX system camera.

Positioning Component Systems

The VSX 7000e and VSX 8000 systems are designed to be placed on a tabletop or in an equipment rack.

If you received a network interface module with your system, you may find it convenient to install it before positioning the system. Refer to the installation sheet that you received with the network interface module.

To position the system:

1. Install the mounting brackets on the system if you need to mount it in an equipment rack, or install the self-adhesive feet if you will place the system on a table or shelf.



2. Place the system in the desired location. Leave enough space to work, so that you can connect the cables easily.
3. Place the camera on or near the monitor displaying the far site so that people look towards the camera during calls.

Powering On the System

Connect power and power on the system after you have connected the rest of the equipment that you will use with it.



Do not use any power supply other than the one supplied with your VSX system. Using the wrong power supply will void the warranty and may damage your system.

The status lights on the front of the system provide this information:

Model	Status Light	System Status
VSX 3000	Off	System is powered off
VSX 3000A VSX 5000 VSX 6000	Steady green light	System is awake and not in a call
VSX 6000A VSX 7000 VSX 7000s	Blinking green light (once)	System received an IR signal while awake and not in a call
	Blinking green light (on 1 sec, off 2 sec)	System is asleep, not in a call
	Steady amber light	System is in a call
	Blinking amber light (once)	System received an IR signal while in a call
	<ul style="list-style-type: none"> Steady red light (VSX 3000, VSX 3000A) Steady red mute indicator on the Polycom microphone (VSX 5000, VSX 6000, VSX 6000A, VSX 7000, VSX 7000s) 	Microphone is muted
VSX 7000e VSX 8000	Off	System is not connected to power
	Steady blue light	System is powered off
	Steady green light	System is powered on
	Blinking green light	System received an IR signal
	Light changes from green to red, then to blue	System is powering off
	Steady red mute indicator on the Polycom microphone	Microphone is muted

Powering On the VSX 3000 or VSX 3000A Desktop System

The VSX 3000 and VSX 3000A systems have three power switches.

To power on the VSX 3000 or VSX 3000A:

1. Press the power switch near the connectors on the back of the system.
2. Press the power switch on the lower back corner of the monitor.
3. Press the power button on the front of the monitor.

Powering On Set-top and Component Systems

For set-top systems, the power switch is on the back panel.

For component systems, the power switch is on the front.

Configuring with the Setup Wizard

When you power on your system for the first time, the setup wizard detects the system's IP and ISDN connections and leads you through the minimum configuration steps required to place a call.

The setup wizard allows you to set a room password, which allows you to limit access to the Admin Settings. The default room password is the 14-digit system serial number from the System Information screen, the bottom of the system, or the back of the system.



Make sure you can recall the room password if you set one. If you forget the password, you will have to reset the system, delete the system files, and run the setup wizard again in order to access the Admin Settings and reset the password. If Security Mode is enabled, the room password is required to access the Reset System screen. If you forget the room password while the system is in Security Mode, contact your Polycom distributor or Polycom Technical Support.

You can run the setup wizard or view the configuration screens in either of these two ways.

- **In the room with the system** — Use the remote control to navigate the screens and enter information. You can use the number pad on the remote control to enter text just like you can with a cell phone.
- **From a remote location** — Use a web browser to access the system's web interface.

Networks

This chapter provides information on network types used worldwide. Please note that not all network types are available in all countries.

Getting the Network Ready

Before you begin configuring the network options, you must make sure your network is ready for video conferencing.

To begin, refer to the *Preparing Your Network for Collaboration* document, available at www.polycom.com/videodocumentation. This document contains information you need to prepare your network, such as worksheets that will help you order ISDN.

Connecting to the LAN

You must connect the system to a LAN to:

- Make IP or SIP calls
- Use the Global Directory Server
- Access the system's web interface
- Use People+Content™ IP
- Update system software using the Polycom Softupdate program

Configuring LAN Properties

To configure LAN properties:

1. Go to **System > Admin Settings > LAN Properties**.
2. Configure these settings on the LAN properties screen:

Setting	Description
Connect to my LAN	Specifies whether the system is part of the LAN. Changing this setting causes the system to restart.
Host Name	Indicates the system's DNS name. Changing this setting causes the system to restart.
IP Address	Specifies how the system obtains an IP address. <ul style="list-style-type: none"> • Obtain IP address automatically — Select if the system gets an IP address from the DHCP server on the LAN. • Enter IP address manually — Select if the IP address will not be assigned automatically. Changing this setting causes the system to restart.
Your IP Address is or Use the Following IP Address	If the system obtains its IP address automatically, this area displays the IP address currently assigned to the system. If you selected Enter IP Address Manually , enter the IP address here. Changing the IP address causes the system to restart.
Domain Name	Displays the domain name currently assigned to the system. If the system does not automatically obtain a domain name, enter one here.

3. Select  and configure these settings:

Setting	Description
DNS Servers	<p>Displays the DNS servers currently assigned to the system.</p> <p>If the system does not automatically obtain a DNS server address, enter up to four DNS servers here.</p> <p>Changing this setting causes the system to restart.</p>
Default Gateway	<p>Displays the gateway currently assigned to the system.</p> <p>If the system does not automatically obtain a gateway IP address, enter one here.</p> <p>Changing this setting causes the system to restart.</p>
Subnet Mask	<p>Displays the subnet mask currently assigned to the system.</p> <p>If the system does not automatically obtain a subnet mask, enter one here.</p> <p>Changing this setting causes the system to restart.</p>
WINS Server	<p>Displays the WINS server currently assigned to the system.</p> <p>If the system does not automatically obtain a WINS server IP address, enter one here.</p> <p>Changing this setting causes the system to restart.</p>
WINS Resolution	<p>Sends a request to the WINS server for WINS name resolution.</p>
LAN Speed	<p>Specify the LAN speed to use. Note that the speed you choose must be supported by the switch.</p> <p>Choose Auto to have the network switch negotiate the speed automatically. If you choose 10 Mbps or 100 Mbps, you must also select a Duplex mode.</p> <p>Polycom recommends setting both the switch and the system to negotiate both speed and duplex automatically.</p> <p>Note: Polycom does not support Auto for the VSX system only or the switch only; the settings for both must be the same.</p> <p>Changing this setting causes the system to restart.</p>
Duplex Mode	<p>Specify the Duplex mode to use. Note that the Duplex mode you choose must be supported by the switch.</p> <p>Choose Auto to have the network switch negotiate the Duplex mode automatically.</p> <p>Polycom recommends setting both the switch and the system to negotiate both speed and duplex automatically.</p> <p>Note: Polycom does not support Auto for the VSX system only or the switch only; the settings for both must be the same.</p> <p>Changing this setting causes the system to restart.</p>

Configuring IP Settings

Specifying H.323 Settings

If your network uses a gatekeeper, the system can automatically register its H.323 name and extension. This allows others to call the system by entering the H.323 name or extension instead of the IP address.

To specify H.323 settings:

1. Go to **System > Admin Settings > Network > IP > H.323 Settings**.
2. Configure these settings on the H.323 Settings screen:

Setting	Description
Display H.323 Extension	Lets users placing a gateway call enter the H.323 extension separately from the gateway ID. If you do not select this setting, users make gateway calls by entering the call information in this format: gateway ID + ## + extension
H.323 Name	Specifies the name that gatekeepers and gateways use to identify this system. You can make point-to-point calls using H.323 names if both systems are registered to a gatekeeper. The H.323 Name is the same as the System Name, unless you change it. Your organization's dial plan may define the names you can use.
H.323 Extension (E.164)	Lets users place point-to-point calls using the extension if both systems are registered with a gatekeeper, and specifies the extension that gatekeepers and gateways use to identify this system. The default H.323 Extension can be changed. Your organization's dial plan may define the extensions you can use.

Configuring the System to Use a Gatekeeper

A gatekeeper is a "network administrator" that supervises network traffic and manages functions such as bandwidth control and admission control. The gatekeeper also handles address translation, which allows users to make calls using static aliases instead of IP addresses that may change each day.

To configure the system to use a gatekeeper:

1. Go to **System > Admin Settings > Network > IP > H.323 Settings**.
2. Select  and configure these settings on the Gatekeeper screen:

Setting	Description
Use Gatekeeper	<p>Specifies whether to use a gatekeeper. Gateways and gatekeepers are required for calls between IP and ISDN.</p> <ul style="list-style-type: none"> • Off — Calls do not use a gatekeeper. • Auto — System automatically attempts to find an available gatekeeper. • Specify — Calls use the specified gatekeeper. Enter the gatekeeper's IP address or name (for example, gatekeeper.companyname.usa.com, or 10.11.12.13). • Specify with PIN — Calls use the specified E.164 address and require an Authentication PIN. This setting is available only when the Avaya® option key is installed.
H.323 Name	<p>Specifies the name that gatekeepers use to identify this system. You can make point-to-point calls using H.323 names if both systems are registered to a gatekeeper.</p> <p>The H.323 Name is the same as the System Name, unless you change it. Your organization's dial plan may define the names you can use.</p>
H.323 Extension (E.164)	<p>Lets users place point-to-point calls using the extension if both systems are registered with a gatekeeper, and specifies the extension that gatekeepers and gateways use to identify this system.</p> <p>The default H.323 Extension is based on the system serial number, but it can be changed. Your organization's dial plan may define the extensions you can use.</p>
Primary Gatekeeper IP Address	<p>If you chose to use an automatically selected gatekeeper, this area displays the gatekeeper that was discovered in the network.</p> <p>If you chose to specify a gatekeeper, enter the IP address of the primary gatekeeper.</p>
Authentication PIN	<p>Specifies the password PIN to use for authentication with the Avaya COMMUNICATIONS MANAGER®. This setting is available when Use Gatekeeper is set to Specify with PIN.</p>

Setting	Description
Use PathNavigator for Multipoint Calls VSX 3000 VSX 3000A VSX 5000 VSX 7000 VSX 7000s VSX 7000e VSX 8000	Lets you specify whether multipoint calls use the system's internal multipoint capability or the Conference on Demand feature available with Polycom PathNavigator™, <i>ReadiManager</i> SE200, or Polycom CMA system. This feature is available only if the system is registered with one of these gatekeepers.

3. Select  to view the IP addresses for the current gatekeeper, the primary gatekeeper, and any alternate gatekeepers.



Points to note about PathNavigator's Conference on Demand feature:

If your organization uses Polycom's PathNavigator, you can use PathNavigator's Conference on Demand feature to place multipoint calls.

In order to place calls using PathNavigator, you need to:

- Register your VSX system with PathNavigator.
- Configure your VSX system to use PathNavigator for multipoint calls (see [Configuring the System to Use a Gatekeeper](#) on page 2-4).
- Create a multi-site entry in the directory (recommended).

When using PathNavigator's Conference on Demand:

- Once the call begins, users cannot add another site to the call, even if the site was in the call originally.

Configuring Integration with Avaya Networks

VSX systems with an Avaya option key can use the following features on an Avaya telephony network:

- Call forwarding (all, busy, no answer) – Configured by the Avaya COMMUNICATIONS MANAGER (ACM) administrator and implemented by the user
- Call coverage – Configured by the ACM administrator
- Transfer – Implemented via flash hook and dialing digits
- Audio conference – Implemented via flash hook and dialing digits
- Call park
- Answer back
- DTMF tones for Avaya functions

Refer to the Avaya documentation and *Getting Started Guide for the VSX Series* for information about these features.

To install the Avaya option key:

1. Obtain a license number from Avaya, then enter that online on the Polycom web site at www.polycom.com/support/video, along with your VSX system serial number. This returns a key code for the Avaya option.
2. On the VSX system go to **System > Admin Settings > General Settings > Options** and enter the key code for the Avaya option.

To configure the VSX system to use Avaya network features:

1. Go to **System > Admin Settings > Network > IP > H.323 Settings > Next**.
Set **Use Gatekeeper** to **Specify with PIN**.
Enter the **H.323 Extension (E.164)** provided by the ACM administrator.
Enter the ACM IP address for **Gatekeeper IP Address**.
Enter the **Authentication PIN** provided by the ACM administrator.
2. Go to **System > Admin Settings > Network > IP > Call Preference**.
Set **Enable H.239**.
3. Go to **System > Admin Settings > General Settings > System Settings > Call Settings**.
Set **Auto Answer Point-to-Point Video** and **Auto Answer Multipoint Video** to **No**.

Configuring the System to Use a Gateway

A gateway performs code and protocol conversion between H.323 (IP), SIP, and H.320 (ISDN), so that users on different networks can call one another. If the system is configured to use a gateway, you must also configure it to use a gatekeeper.

To configure the system to use a gateway:

1. Go to **System > Admin Settings > Network > IP > H.323 Settings**.
2. Select  two or three times and configure these settings on the Gateway screen:

Setting	Description
Country Code	Specifies the country code for the system's location.
Area Code	Specifies the area or city code for the system's location.
Number	Specifies the gateway's number.
H.323 Extension (E.164)	Specifies the extension that identifies this system for incoming gateway calls. The default H.323 Extension can be changed.
Gateway Number Type	Specifies the number type users enter to call this system: <ul style="list-style-type: none"> • Direct Inward Dial — Users enter an internal extension to call this system directly. Note: If you choose this setting, you must also register the number with the gatekeeper as an E.164 alias. • Number + Extension — Users enter the gateway number and the system's extension to call this system.
Number of Digits in DID Number	Specifies the number of digits in the DID number. The national or regional dialing plan for your location determines the standard number of digits. For instance, the US standard is 7 digits.
Number of Digits in Extension	Specifies the number of digits in the extension used when Direct Inward Dial is selected. Your organization's dial plan determines this number.

3. Select  and enter a prefix or suffix for each bandwidth you want to allow for gateway calls.

Associating prefixes and suffixes with particular bandwidths on your gateway can optimize the use of bandwidth by your organization. Be sure the gateway is configured to use the same prefixes and suffixes you define for the system.

Specifying SIP Settings

If your network supports the Session Initiation Protocol (SIP), you can use SIP to connect IP calls.

To specify SIP Settings:

1. Go to **System > Admin Settings > Network > IP > SIP Settings**.
2. Configure these settings on the SIP Settings screen:

Setting	Description
Transport Protocol	Indicates the protocol the system uses for SIP signaling. The SIP network infrastructure in which your VSX system is operating determines which protocol is required. For example, if your VSX system is operating in a Microsoft® Live Communication Server (LCS) SIP network, choose TCP . If your VSX system is operating in a Nortel Multimedia Communication Server (MCS) SIP network, choose UDP .
Authentication Name	Specifies the name to use for authentication when registering with a SIP Registrar Server. If you leave this field blank, the User Name is used for authentication.
User Name	Specifies the system's SIP name. If you leave this field blank, the system's IP address is the SIP user name.
Password	Specifies the password that authenticates the system to the Registrar Server.
Registrar Server	Specifies the DNS name or IP address of the SIP Registrar Server. By default, the SIP signaling is sent to port 5060 on the registrar server. To specify a different port, add it to the address as shown here: 10.11.12.13:5070
Proxy Server	Specifies the DNS name or IP address of the SIP Proxy Server. If you leave this field blank, no proxy server is used. By default, the SIP signaling is sent to port 5060 on the proxy server. To specify a different port, add it to the address as shown here: 10.11.12.13:5070

Setting	Description
PCAS	<p>Specifies whether to register to the PCAS (Polycom Conferencing Application Server).</p> <ul style="list-style-type: none"> • Auto — System automatically finds the PCAS. • Specify — Calls use the specified PCAS. Enter the PCAS IP address or name, for example pcas.companyname.xxxx, or 10.11.12.13. • Off — Calls do not use the PCAS. <p>Note: For information about VSX support for SIP sites using Lotus® Sametime® or Lotus Notes® in audio and video calls with instant meetings, scheduled meetings, and Click2Call via the RAS200I PCAS, refer to the Lotus Sametime or Lotus Notes Integrated Video Conferencing Deployment Guide or User Guide.</p>
PCAS Server Address	<p>Enter the PCAS IP address or name when PCAS is set to Specify. If PCAS is set to Auto, the system displays the server address in this field. When a PCAS Server Address is configured, Registrar Server and Proxy Server are set automatically.</p> <p>Note: For information about VSX support for SIP sites using Lotus Sametime or Lotus Notes in audio and video calls with instant meetings, scheduled meetings, and Click2Call via the RAS200I PCAS, refer to the Lotus Sametime or Lotus Notes Integrated Video Conferencing Deployment Guide or User Guide.</p>



Points to note about SIP:

Because some advanced video conferencing capabilities are not yet standardized, and many capabilities depend on the SIP server, the following features are not supported using SIP.

Examples of features that are not supported using SIP are:

- Polycom Video and Audio Error Concealment
- Encryption
- People and Content (H.239 and Polycom People+Content)
- H.263 Pro-Motion™

Specifying Quality of Service

Set the Quality of Service options for the way your network handles IP packets during video calls.

To specify Quality of Service:

1. Go to **System > Admin Settings > Network > IP > Quality of Service**.

2. Configure these settings on the Quality of Service screen:

Setting	Description
Type of Service	Specifies your service type and lets you choose how to set the priority of IP packets sent to the system for video, audio, and far-end camera control: <ul style="list-style-type: none"> • IP Precedence — Represents the priority of IP packets sent to the system. The value can be between 0 and 5. If this setting is selected, enter the value in the Type of Service Value field. • DiffServ — Represents a priority level between 0 and 63. If this setting is selected, enter the value in the Type of Service Value field.
Type of Service Value	Specifies the IP Precedence or Diffserv value for Video, Audio, and Far End Camera Control.
Maximum Transmission Unit Size	Specifies the Maximum Transmission Unit (MTU) size used in IP calls. If the video becomes blocky or network errors occur, packets may be too large; decrease the MTU. If the network is burdened with unnecessary overhead, packets may be too small; increase the MTU. <ul style="list-style-type: none"> • Auto — Allows the system to select the MTU size.
Enable PVEC	Allows the system to use PVEC (Polycom Video Error Concealment) if packet loss occurs.
Enable RSVP	Allows the system to use Resource Reservation Setup Protocol (RSVP) to request that routers reserve bandwidth along an IP connection path. Both the near site and far site must support RSVP in order for reservation requests to be made to routers on the connection path.

3. Select  and configure these settings on the Bandwidth screen:

Setting	Description
Dynamic Bandwidth	Specifies whether to let the system automatically find the optimum line speed for a call.
Maximum Transmit Bandwidth	Specifies the maximum transmit line speed between 64 kbps and 1920 kbps.
Maximum Receive Bandwidth	Specifies the maximum receive line speed between 64 kbps and 1920 kbps.

Configuring the System for Use with a Firewall or NAT

A firewall protects an organization's IP network by controlling data traffic from outside the network. Unless the firewall is designed to work with H.323 video conferencing equipment, you must configure the system and the firewall to allow video conferencing traffic to pass in and out of the network.

Firewall Settings

Network Address Translation (NAT) network environments use private internal IP addresses for devices within the network, while using one external IP address to allow devices on the LAN to communicate with other devices outside the LAN. If your system is connected to a LAN that uses a NAT, you will need to enter the **NAT Public (WAN) Address** so that your system can communicate outside the LAN.

To set up the system to work with a firewall or NAT:

1. Go to **System > Admin Settings > Network > IP > Firewall**.
2. Configure these settings on the Firewall screen:

Setting	Description
Fixed Ports	<p>Lets you specify whether to define the TCP and UDP ports.</p> <ul style="list-style-type: none"> • If the firewall is not H.323 compatible, enable this setting. The VSX system assigns a range of ports starting with the TCP and UDP ports you specify. The system defaults to a range beginning with port 3230 for both TCP and UDP. <p>Note: You must open the corresponding ports in the firewall. You must also open the firewall's TCP port 1720 to allow H.323 traffic.</p> <ul style="list-style-type: none"> • If the firewall is H.323 compatible or the system is not behind a firewall, disable this setting.
TCP Ports UDP Ports	<p>Lets you specify the beginning value for the range of TCP and UDP ports used by the system. The system automatically sets the range of ports based on the beginning value you set.</p> <p>Note: You must also open the firewall's TCP port 1720 to allow H.323 traffic.</p>

3. Select  and configure these settings:

Setting	Description
Enable H.460 Firewall Traversal	<p>Allows the system to use H.460-based firewall traversal. For more information, refer to H.460 NAT Firewall Traversal on page 2-13.</p>

Setting	Description
NAT Configuration	<p>Lets you specify whether the system should determine the NAT Public WAN Address automatically.</p> <ul style="list-style-type: none"> • If the system is behind a NAT that allows HTTP traffic, select Auto. • If the system is behind a NAT that does not allow HTTP traffic, select Manual. • If the system is not behind a NAT or is connected to the IP network through a Virtual Private Network (VPN), select Off. • If the system is behind a firewalled NAT router that is UPnP™ (Universal Plug and Play) certified, select UPnP. <p>Many routers used in homes and small businesses support UPnP NAT traversal. If this is your situation, try selecting UPnP first. If this selection does not work for your router, select Auto or Manual.</p>
NAT Public (WAN) Address	Displays the address that callers from outside the LAN use to call your system. If you chose to configure the NAT manually, enter the NAT Public Address here.
NAT is H.323 Compatible	Specifies that the system is behind a NAT that is capable of translating H.323 traffic.
Address Displayed in Global Directory	Lets you choose whether to display this system's public or private address in the global directory.



Visit the Polycom Security Center at www.polycom.com for timely security information. Systems deployed outside a firewall are potentially vulnerable to unauthorized access. You can also register to receive periodic email updates and advisories.

H.460 NAT Firewall Traversal

You can configure VSX systems to use standards-based H.460.18 and H.460.19 firewall traversal, which allows video systems to more easily establish IP connections across firewalls.

The following illustration shows how a service provider might provide H.460 firewall traversal between two enterprise locations. In this example the V²IU™ traversal server gateway is on the edge of the service provider network and facilitates IP calls between VSX systems behind different firewalls.

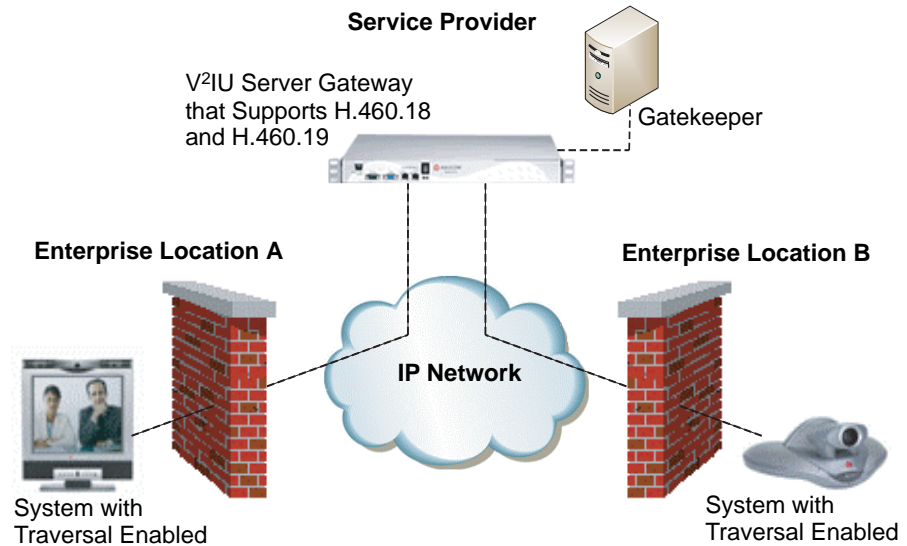

To use this traversal, VSX systems and firewalls must be configured as follows:

- Enable firewall traversal on the VSX system.
- Register the VSX system to an external V²IU Traversal Server Gateway that supports the H.460.18 and H.460.19 standards.
- Make sure that firewalls being traversed allow VSX systems behind them to open outbound TCP and UDP connections.
 - Firewalls with a stricter rule set should allow VSX systems to open at least the following outbound TCP and UDP ports: 1720 (TCP), 14085-15084 (TCP) and 1719(UDP), 16386-25386 (UDP).
 - Firewalls should permit inbound traffic to TCP and UDP ports that have been opened earlier in the outbound direction.
- For best interoperability, make sure that H.323 protocol-aware features are disabled on firewalls being traversed.

To enable firewall traversal on a VSX system:

1. Go to **System > Admin Settings > Network > IP > Firewall > Next.**
2. Select **Enable NAT/Firewall Traversal.**

Connecting to ISDN or Other Networks

The following network interface modules are available with some VSX systems:

- **BRI** – Allows you to connect to an ISDN network using up to four BRI lines.
- **PRI** – Allows you to connect to an ISDN network using a PRI line.
- **V.35/RS-449/RS-530** – Allows you to connect to third-party network equipment, including encryption equipment and RS-366 dialers.

The table below shows the network interfaces available for each model.

	ISDN - BRI	ISDN - PRI	V.35/RS-449/RS-530
VSX 3000 VSX 3000A	Built in to model with IP and ISDN	Not Available	Not Available
VSX 5000	Available in a separate housing	Not Available	Not Available
VSX 6000A	Available in a separate housing	Not Available	Not Available
VSX 6000	Not Available	Not Available	Not Available
VSX 7000	Available	Available	Available
	Network interface modules fit into subwoofer housing		
VSX 7000s	Available	Available	Available
	Network interface modules fit into subwoofer housing		
VSX 7000e	Available	Available	Available
	Network interface modules fit into back panel		
VSX 8000	Available	Available	Available
	Network interface modules fit into back panel		

Connecting Desktop Systems to the ISDN BRI Network

The VSX 3000 and VSX 3000A desktop systems are available with or without the built-in Quad BRI network interface. The setup sheet for the IP with ISDN system shows how to connect it to a BRI network.

If you purchased the VSX 3000 or VSX 3000A system with IP and ISDN, you will need:

- **NT-1 device**, if the system will be connected to a network that provides a U interface

- **Up to 4 BRI lines** that will not be shared with other equipment

If you connect fewer than four BRI ports on the system's network interface module, connect them in ascending order, starting with port 1.

The diagram below shows a general view of how to connect the VSX 3000 or VSX 3000A system to the ISDN using the Quad BRI network interface.

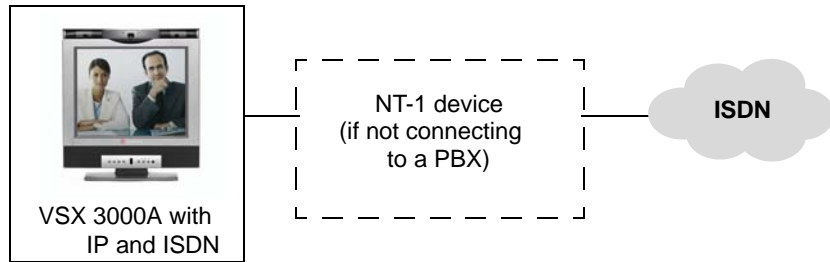

Connecting Set-top and Component Systems to ISDN or Other Networks

If you received a network interface module with your system, you may find it convenient to install it before positioning the system. Refer to the setup sheet that you received with the network interface module.

You will need the following network hardware:

If your network is...	You will need
BRI	<ul style="list-style-type: none"> • NT-1 device, if the system will be connected to a network that provides a U interface. Do not use an NT-1 device if your PBX network provides an S/T interface. • Up to 4 BRI lines that will not be shared with other equipment. <p>If you connect fewer than four BRI ports on the system's network interface module, connect them in ascending order, starting with port 1.</p>

If your network is...	You will need
PRI (North America and Japan)	<ul style="list-style-type: none"> • PBX crossover cable, if required for your PBX. • Channel Service Unit (CSU) — not required if you connect the system to a PBX network. • PRI line.
PRI (outside North America and Japan)	<ul style="list-style-type: none"> • 75 W coaxial adapter, if the network connection is via a 75 W coaxial cable. • PBX crossover cable, if required for your PBX. • PRI line.
Serial V.35/RS-449/ RS-530	<ul style="list-style-type: none"> • Third-party network equipment and cables. Contact your network equipment vendor to obtain the appropriate cables for the equipment you connect to this interface. If you use only one cable, connect it to port 1 of the network interface module and to the lowest-numbered port of the data communications equipment.

The diagram below shows a general view of how network interface modules are connected in set-top and component VSX systems.

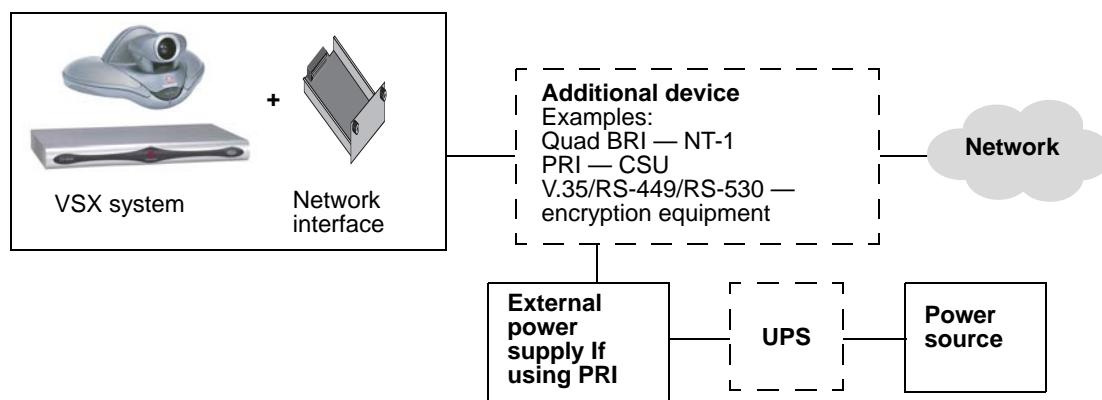

Quad BRI Network Interface Status Lights

On VSX 5000, VSX 6000A, VSX 7000, VSX 7000s, VSX 7000e, and VSX 8000 systems, the BRI network interface lights are located on the network interface module. On the VSX 3000 system, the lights are located on the back of the system near the BRI connectors.

When the BRI network interface...	It means...
Indicators are off	<ul style="list-style-type: none"> No power to the system, or The system is not connected to the network, or The system is not receiving a clock signal from the network, or The system is restarting.
Green indicator is on	The system is receiving a clock signal from the network.
Yellow indicator is on	The system is able to make a call.
Green and yellow indicators are on	<ul style="list-style-type: none"> The system is receiving a software update, or The system is operating normally.

PRI Network Interface Status Lights

The PRI network interface module is available for VSX 7000, VSX 7000s, VSX 7000e, and VSX 8000 systems.

When the PRI network interface...	It means...
Indicators are off	No power to the system.
Red indicator is on or blinking	The system is not connected to the ISDN network, or there is a problem with the ISDN line.
Yellow indicator is on or blinking	There is a problem with the ISDN line.
Green indicator is on	The system is able to make and receive calls.

Serial V.35/RS-449/RS-530 Network Interface Status Lights

The serial V.35/RS-449/RS-530 network interface module is available for VSX 7000, VSX 7000s, VSX 7000e, and VSX 8000 systems.

When the serial V.35/RS-449/RS-530 network interface...	It means...
Indicators are off	<ul style="list-style-type: none"> No power to the system, or The system is not communicating with the network, or The system is restarting.
Yellow indicator is on	The system is receiving a clock signal from the network (able to make a call).
Yellow and green indicators are on	The system is in a call.

Configuring ISDN and Other Network Interface Settings

You can configure a network interface option if the corresponding network interface module is installed. The system automatically detects the type of interface installed and displays only the required configuration screens.

Configuring the BRI Network Interface

To configure the ISDN network interface settings:

1. Go to **System > Admin Settings > Network > ISDN**.
2. Configure these settings:

Setting	Description
Enable ISDN H.320	Allows this system to make H.320 (ISDN) calls.
Number of ISDN Channels to Dial in Parallel	Specifies how many channels to dial at one time. You can specify up to eight channels. If you experience network problems, decrease the number.
Outside Line Dialing Prefix	Specifies the ISDN dialing prefix used to call outside the network.
Numbering Plan	Specifies the appropriate numbering plan for your location, if it differs from the default.

Setting	Description
ISDN Switch Protocol	Specifies the protocol used by your network's switch.
ISDN Voice Algorithm	Specifies which voice algorithm (aLaw or uLaw) is used for ISDN voice calls. Do not change this setting unless you experience audio issues in all ISDN voice calls.
Auto BRI Configuration	Allows the NI-1 switch to automatically configure the directory numbers and SPIDs. This setting is only available if you have selected the NI-1 switch protocol.

3. Select  and configure these settings:

Setting	Description
Country, Country Code	Displays the country selected as the system's location and the country code used for international calls to the system. To specify the system's location, go to System > Admin Settings > General Settings > Location . The system automatically supplies the country code when you specify the country.
Area Code	Specifies the area code for this system's location.
Directory Numbers	Specifies the numbers assigned to the B1 and B2 channels for each BRI line. The two numbers for a line may be the same or different, depending on the switch protocol in use.
Enable	Specifies whether to enable the associated ISDN line. If you selected Standard ETSI Euro-ISDN protocol, you must enable all BRI lines that you expect to be active, and you must not enable lines that will not be connected. You may want to disable a particular line if there are problems with the line that generate continuing error messages.

4. If you have configured the ISDN switch protocol to be AT&T 5ESS Multipoint, NI-1, or Nortel DMS-100, select  and enter the ISDN BRI SPIDs provided by your service provider.

After you enter the SPIDs, the system verifies them. If the system is unable to verify the SPIDs, make sure the system is connected and that the ISDN numbers you entered are correct.

If you do not have the SPIDs from your service provider, you can click **Start** to Auto Detect SPIDs.

Configuring the PRI Network Interface



Points to note about fractional PRI:

- Assigned channels must begin with channel 1, and the channel numbers must be consecutive.
- A D channel must be provided.
- Outbound call bandwidth must not exceed the available bandwidth.

To configure the ISDN network interface settings:

1. Go to **System > Admin Settings > Network > ISDN**.
2. Configure these settings:

Setting	Description
Enable ISDN H.320	Allows this system to make H.320 (ISDN) calls.
Area Code	Specifies the area code for this system's location.
PRI Video Number	Specifies the ISDN number assigned to this system.
Outside Line Dialing Prefix	Specifies the ISDN dialing prefix used to call outside the network.
BONDING: Calling Endpoint Uses the Original ISDN Number	Specifies the use of a bonding standard. Incoming bonded calls will use the original number received to connect all remaining lines required for the call.

3. Select  and configure these settings:

Setting	Description
Line Signaling	Specifies the framing format in use. This setting is configurable for PRI E1, read-only for PRI T1.
External CSU North America only	Specifies whether this system uses an external or internal Channel Service Unit (CSU).

Setting	Description
Line Build Out PRI T1 only	For systems using an internal CSU, indicates the output attenuation in dB. Your service provider can provide you with these values. For systems using an external CSU, indicates the length (in feet) of the RJ-45 cable that connects the PRI network interface module to the CSU.
Switch Protocol	Specifies the Network switch protocol. The available choices are determined by the system's country settings. This setting is read-only for PRI E1, configurable for PRI T1. Your ISDN service provider can tell you which protocol your network uses. If you later change the Country setting, the PRI switch protocols available may also change, and you may be prompted to configure a different PRI switch protocol.
ISDN Voice Algorithm	Specifies which voice algorithm (aLaw or uLaw) is used for ISDN voice calls. Do not change this setting unless you experience audio issues in all ISDN voice calls.

4. Select  and configure these settings:

Setting	Description
Numbering Plan	Specifies the appropriate numbering plan for your location, if it differs from the default.
International Dialing Prefix	Specify the dialing prefix needed for international calls.
Call-by-Call	Specifies a code that the system sends to the telephone company switch to request a special service, if such a code is required. Consult your telephone service provider to determine the proper call-by-call value.
Number of ISDN Channels to Dial in Parallel	Specifies how many channels to dial at one time. You can specify up to eight channels. If you experience network problems, decrease the number. Set this value to 1 for serial dialing. Serial dialing is not recommended unless you have trouble connecting calls using parallel dialing.
Restore Defaults	Resets all values on this screen. This does not affect other PRI settings.

5. Select  and configure these settings:

Setting	Description
PRI Line Type	Displays read-only information about the system and its configuration.
Number of Active Channels	
D Channel Location	
Network Mode	
Clock Source	
Terminal Endpoint ID TEI	
Line Termination PRI E1 only	

6. Select  and select a channel to activate or deactivate it. Active channels are represented by a green icon, and inactive channels are represented by a gray icon.



Make sure that channels are activated and deactivated only by a knowledgeable network professional so that the system operates properly and can dial at the desired rates.

Configuring the Serial V.35/RS-449/RS-530 Network Interface

To configure the V.35/RS-449/RS-530 network interface settings:

1. Go to **System > Admin Settings > Network > V.35/RS-449/RS-530**.
2. Configure these settings:

Setting	Description
Enable V.35/RS-449/RS-530	Allows the system to connect to a terminal adapter using a V.35, RS-449, or RS-530 connection.
V.35 Ports Used	Specifies whether one or two lines are connected.
RS-366 Dialing	Allows users to dial calls from this system. Clear this setting if this is a dedicated connection or if another device is used for dialing calls.
Area Code Port 1 Port 2	Specifies the area code and number(s) that other sites dial to reach this system. If this is a dedicated connection, leave these fields blank.

3. Select  and configure these settings:

Setting	Description
Prefix	Lets you specify the dialing prefix required to reach an outside line.
Calling Profile	Lets you specify what data communications equipment is connected to the network interface. The system automatically displays the default prefixes, suffixes, and calling speeds required by that device. If your device is not listed, select Custom .
Speed	Lets you define the prefixes or suffixes to use for each speed used in a Custom Calling Profile. For information about required prefixes and suffixes, see the documentation that came with the device. If you choose a predefined Calling Profile, this information is supplied for you.

4. Select  and configure these settings:

Setting	Description
ST	Lets you specify the signaling required by the external device connected to the system. Specify normal or inverted, as appropriate. In most cases, normal signaling is appropriate. If your system is connected to Ascend equipment, you may need to set CTS to Ignore .
RT	
RTS	
CTS	
DSR	
DCD	
DTR	
Answer on DSR	Specifies that the system should begin the call when it detects a DSR signal.
Delayed DCD Hangup	Specifies how long the system waits to end the call after a DCD signal is lost (for example, during a call via satellite).
DTR Pulse Duration (secs)	Specifies how long the DTR signal goes low after the far site hangs up. When the pulse is too short, the call may not clear. If your system is connected to ADTRAN equipment, you may need to adjust DTR pulse duration.
Trigger Call on H.320 Data	Specifies whether the call starts when H.320 data is detected at the V.35 interface while set for direct connect.

5. Select  and configure these settings:

Setting	Description
Crypto Resync	Allows a VSX system connected to cryptographic equipment to signal when it loses video synchronization during a call. The cryptographic equipment can then resynchronize with the far site.
Use RTS Signal for Resync Pulse	Allows the system to send the resynchronization pulse on the RTS signal. Select this setting if your data communications equipment uses the V.35 or RS-449 capability of the serial V.35/RS-449/RS-530 network interface. Note: When you select this setting, the RTS no longer functions as the Request To Send signal.
Time Between Pulses (sec)	Specifies whether the system should set the time between resync pulses automatically or use the number of seconds you enter.
Pulse Width (millisec)	Specifies whether the system should set the pulse duration automatically or use the number of milliseconds you enter.

6. Select  and configure these settings:

Setting	Description
Enable Broadcast Mode	Enables support for H.331 broadcast transmissions from the VSX system. Broadcast mode enables the system to send video and audio to many other systems, such as large satellite networks.
Enable People+Content	Enables People+Content for broadcast mode.
Video Format	Specifies the resolution at which video is transmitted.
Video Protocol	Specifies the protocol used to transmit video. Choose the lowest protocol supported by all systems in the conference.
Audio Protocol	Specifies the protocol used to transmit audio.
Frame Rate	Specifies the frame rate to use.

Connecting to a Phone Line

You can use a SoundStation VTX 1000® conference phone with set-top and component systems to place, add, or redial video calls, or to add video to audio calls.

You can connect an analog phone line to the VSX 7000e or VSX 8000 to make regular telephone calls with the system or to add audio-only participants to video calls.



The country setting must be configured correctly on the Polycom system to ensure proper operation of the phone line and to comply with local telephony regulations.

Configuring Telephony

To configure telephony options:

1. Go to **System > Admin Settings > Network > Telephony**.
2. Configure these settings on the Telephony screen:

Setting	Description
Room Telephone Number	Enter the telephone number of the room where the system is located.
System Telephone Number VSX 7000e VSX 8000	Specifies the analog phone number of the system, including country and area codes for the system's location.
VTX Telephone Number VSX 5000 VSX 6000 VSX 6000A VSX 7000 VSX 7000s VSX 7000e VSX 8000	Specifies the number of the SoundStation VTX 1000® conference phone that is connected to the system.
Outside Line Dialing Prefix	Specifies the dialing prefix used to call outside the network.

To configure the analog phone line (POTS line) for the VSX 7000e or VSX 8000 system:

1. Go to **System > Admin Settings > Network > Telephony**.
Enter the **System Telephone Number** for the analog phone line.
2. Go to **System > Admin Settings > Network > Call Preference**.
Enable Analog Phone.
3. Go to **System > Admin Settings > Network > Call Preference > Next**.
Add **Analog Phone** to the Dialing Order.

Configuring Call Preferences

Call preferences help you manage the network bandwidth used for calls. You can specify the default and optional call settings for outgoing calls. You can also limit the call speeds of incoming calls.

To configure call preferences:

1. Go to **System > Admin Settings > Network > Call Preference**.
2. Configure these settings on the Call Preference screen:

Setting	Description
Basic Mode	Enables a limited operating mode that uses H.261 for video and G.711 for audio. This mode provides administrators with a workaround for interoperability issues that cannot be solved using other methods. The Basic Mode setting stays in effect until you change it. Basic Mode disables many system features such as content sharing, far end camera control, and advanced audio and video algorithms. Use Basic Mode only when calling systems that fail to operate properly with these advanced features.
H.239	Specifies standards-based People+Content data collaboration.
IP H.323	Allows the system to make IP calls.
SIP	Allows the system to use SIP when connecting IP calls.
ISDN H.320 VSX 3000 VSX 3000A VSX 7000 VSX 7000s VSX 7000e VSX 8000	Allows the system to make ISDN calls. This selection is only available when the system has ISDN networking capability.

Setting	Description
Voice Over ISDN	Allows the system to make voice-only calls to phones connected to an ISDN network, such as an organization's PBX.
V.35/RS-449/RS-530 VSX 7000 VSX 7000s VSX 7000e VSX 8000	Allows the system to make calls through your third-party network equipment. This selection is only available when the system has a V.35/RS-449/RS-530 network module installed.
Analog Phone VSX 7000e VSX 8000	Allows the system to make voice-only calls to any phone using an analog phone line. Disable this setting to remove a SoundStation VTX 1000 conference phone from the dialing order.
ISDN Gateway	Allows users to choose whether to place IP-to-ISDN calls through a gateway.



To make the enabled call types available on the Place a Call screen, you must enable the **Call Quality** setting described on page 7-4.

3. Select  and configure these settings on the Network Dialing screen:

Setting	Description
Preferred Dialing Method	Specifies the preferred method for dialing various call types. If set to Auto , calls use the configured Dialing Order. If set to Manual , the system prompts the user to select the call type from a list when placing a call.
Dialing Order	Specifies how the system places calls to directory entries that have both IP and ISDN numbers. It also specifies how the system places calls dialed manually, when the call type selection is either unavailable on the home screen or set to Auto . If a call attempt does not connect, the system tries to place the call using the next call type in the Dialing Order. This setting is available only when Preferred Dialing Method is set to Auto . For more information, refer to Configuring Dialing Order Settings on page 2-29.

4. Select  to go to the Preferred Speeds screens and configure these settings:

Setting	Description
Preferred Speed for Placing Calls	<p>Determines the speeds that will be used for calls from this system when:</p> <ul style="list-style-type: none"> • Call Quality is set to Auto on the home screen and Directory screen, or • The Call Quality setting is not available for users. <p>If the far-site system does not support the selected speed, the system automatically negotiates a lower speed.</p>
Maximum Speed for Receiving Calls	<p>Allows you to restrict the bandwidth used when receiving calls.</p> <p>If the far site attempts to call the system at a higher speed than selected here, the call is re-negotiated at the speed specified in this field.</p>

5. Select  to go to the **Call Speeds** screen and specify the call speeds to make available to users, if you are allowing them to choose speeds on a call-by-call basis.

Configuring Dialing Order Settings

If the call type on the home screen is set to a specific call type, the system does not attempt to place the call using a different call type, even if other types are listed in the Dialing Order.

You can configure the VSX system so that users can choose to place IP-to-ISDN or ISDN-to-IP calls through a gateway.

To allow users to place an IP-to-ISDN call through a gateway:

1. Make sure the system is registered with a gatekeeper.
2. Go to **System > Admin Settings > Network > Call Preference** and select **Enable ISDN Gateway**.

3. If you want to allow users to place IP-to-ISDN calls through a gateway when calling from the directory, do one of the following:
 - On the Network Dialing screen, set **Preferred Dialing Method** to **Auto** and select **ISDN Gateway** as the first choice under **Dialing Order**. With this configuration, calls placed from the directory will be placed through a gateway first if an ISDN number exists.
 - On the Network Dialing screen, set **Preferred Dialing Method** to **Manual**. With this configuration, users can select **ISDN Gateway** from the list of call types that appears when placing a call from the directory.

To allow users to place an ISDN-to-IP call through a gateway:

1. If you want to allow users to place ISDN-to-IP calls through a gateway when dialing manually:
 - a. Make sure **Call Quality** is enabled on the Home Screen Settings screen. This setting displays the Call Type selection on the Place a Call screen.
 - b. On the Network Dialing screen, select **IP Gateway** next to **ISDN** in the **Dialing Order**.

With this configuration, users can enter the gateway address in the dialing field, along with an extension in extension field, and select **IP H323** in the call type list.

2. If you want to allow users to place ISDN-to-IP calls through a gateway when calling from the directory, do one of the following:
 - On the Network Dialing screen, set **Preferred Dialing Method** to **Auto** and select **IP Gateway** next to **ISDN** under **Dialing Order**. With this configuration, calls placed from the directory will be placed through a gateway first if a gateway address is present in the ISDN number field and an extension is present in the Extension field.
 - On the Network Dialing screen, set **Preferred Dialing Method** to **Manual**. With this configuration, users can select **IP Gateway** from the list of call types that appears when placing a call from the directory.

Monitors and Cameras

Connecting Monitors

If you have a set-top or component system, you need to connect a monitor to the system to see the people at the far site. Refer to your system's setup sheet for connection details. The following table shows the different ways you can connect monitors to a VSX system. The main monitor is the monitor that displays the VSX system user interface.

VSX System	Main Monitor	Second Monitor
VSX 5000, VSX 6000, VSX 6000A, VSX 7000, VSX 7000s, VSX 7000e, VSX 8000	TV (NTSC or PAL)	None
VSX 5000, VSX 6000, VSX 6000A, VSX 7000, VSX 7000s, VSX 7000e, VSX 8000	TV (NTSC or PAL)	TV (NTSC or PAL)*
VSX 5000, VSX 6000, VSX 6000A, VSX 7000, VSX 7000s, VSX 7000e, VSX 8000	TV (NTSC or PAL)	VGA monitor*
VSX 5000, VSX 6000A	VGA monitor	Not available
VSX 7000s, VSX 7000e, VSX 8000	VGA monitor	TV (NTSC or PAL)
*Requires an additional display adapter on the VSX 6000 and VSX 7000.		

Using a Desktop System as the Monitor for a Computer

You can use the VSX 3000 or VSX 3000A system as a high-resolution XGA display for your computer, as shown on the system setup sheet.



To use the VSX 3000 or VSX 3000A system as the monitor for a computer:

1. Connect the VGA cable from the VGA connector on the back of the VSX 3000 or VSX 3000A system to the VGA connector on your computer.
2. To use the system's built-in speakers for your computer's audio, connect an audio cable from your computer to the audio input connector on the left side of the VSX 3000 or VSX 3000A system.

Configuring Monitor Settings

To configure monitors:

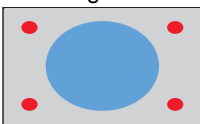
1. Go to **System > Admin Settings > Monitors > Monitors**.
2. Configure these settings on the Monitors screen:

Setting	Description
Monitor 1 VSX 5000 VSX 6000 VSX 6000A VSX 7000 VSX 7000s VSX 7000e VSX 8000	<p>Specifies the main monitor's aspect ratio:</p> <ul style="list-style-type: none"> • 4:3 — Select if you are using a regular TV monitor. • 16:9 — Select if you are using a wide-screen monitor. <p>Specifies the first monitor's format:</p> <ul style="list-style-type: none"> • S-Video — Select if the main monitor is connected to a VSX 8000 system using an S-Video cable. • Composite — Select if the main monitor is connected to a VSX 8000 system using a composite video cable and S-Video to RCA adapter. • VGA — Select if you are using a VGA monitor as the primary display device for a VSX 5000, VSX 6000A, VSX 7000s, VSX 7000e, or VSX 8000. If you select VGA, your VGA monitor must be set to SVGA (800 x 600) or XGA (1024 x 768) at 60 Hz. Monitor 2 is disabled on the VSX 5000, VSX 6000, VSX 6000A, and VSX 7000. Monitor 2 is disabled or is connected to S-Video or composite video on the VSX 7000s, VSX 7000e, and VSX 8000. <p>Note: If you select 16:9, you will also need to set up the monitor for full-screen display. In the monitor's setup menu, choose the setting that stretches the picture uniformly without clipping the edges, which is usually called Full, Wide screen, or 16x9.</p> <p>Use this setting:  Not this setting: </p>
Output upon Screen Saver Activation VSX 5000 VSX 6000 VSX 6000A VSX 7000 VSX 7000s VSX 7000e VSX 8000	<p>Specifies the screen saver output for Monitor 1:</p> <p>Specifies whether black video or no signal is sent to the monitor when the system goes to sleep and the screen saver activates.</p> <p>Select Black if you want to display screen saver text or a screen saver news feed. This is the recommended setting to prevent burn-in for TV monitors.</p> <p>Select No Signal if you want the display to react as if it is not connected when the system goes to sleep. This is the recommended setting for VGA monitors and projectors.</p>

Setting	Description
<p>Monitor 2</p> <p>VSX 5000 VSX 6000 VSX 6000A VSX 7000 VSX 7000s VSX 7000e VSX 8000</p>	<p>Specifies the second monitor's aspect ratio:</p> <ul style="list-style-type: none"> • Off — Select if you do not have a second monitor. • 4:3 — Select if you are using a regular TV monitor as the second monitor. • 16:9—Select if you are using a wide-screen monitor as the second monitor. On the monitor, select the display mode that uniformly stretches the video from side to side, which is usually called Full, Wide screen, or 16x9. <p>Specifies the second monitor's format:</p> <ul style="list-style-type: none"> • S-Video — Select if you have a second monitor connected to the system's S-Video output using an S-Video cable. • Composite — Select if you have a second monitor connected to the system using a composite video cable. • VGA — Select if you are using a VGA monitor as the second display device. <p>Note: When Monitor 1 is configured as a VGA monitor on the VSX 7000s, VSX 7000e, or VSX 8000, Monitor 2 can be disabled or connected to S-Video or composite video.</p>
<p>Output upon Screen Saver Activation</p> <p>VSX 5000 VSX 6000 VSX 6000A VSX 7000 VSX 7000s VSX 7000e VSX 8000</p>	<p>Specifies the screen saver output for Monitor 2:</p> <p>Specifies whether black video or no signal is sent to the monitor when the system goes to sleep and the screen saver activates.</p> <p>Select Black if you want to display screen saver text or a screen saver news feed. This is the recommended setting to prevent burn-in for TV monitors.</p> <p>Select No Signal if you want the display to react as if it is not connected when the system goes to sleep. This is the recommended setting for VGA monitors and projectors.</p>
<p>VCR</p> <p>VSX 7000s VSX 7000e VSX 8000</p>	<p>Specifies the VCR/DVD Player output format:</p> <ul style="list-style-type: none"> • S-Video — Select if you have a VCR or DVD player connected to the system's S-Video output using an S-Video cable. • Composite — Select if you have a VCR or DVD player connected to the system output using a composite video cable. <p>Note: On the VSX 7000s, VSX 7000e, and VSX 8000, the VCR monitor input is always enabled and can be connected to S-Video or composite video.</p>

Setting	Description
PIP	<p>Specifies PIP (Picture-in-Picture) behavior:</p> <ul style="list-style-type: none"> • Camera — The PIP window is displayed when the call is first connected and when a user moves the camera, uses presets, or switches to a different camera source. • On — The PIP window stays on for the duration of the call. • Off — The PIP window is not displayed during the call. • Auto — The PIP window is displayed when a user picks up the remote. <p>Note: PIP settings are also available in the User Settings screen. Users can turn the PIP on or off and change its location on the screen using  PIP on the remote control.</p>

3. Select  and configure these settings:

Setting	Description
Monitor 1 VSX 5000 VSX 6000 VSX 6000A VSX 7000 VSX 7000s VSX 7000e VSX 8000	Select the video source(s) to display on Monitor 1. For more information about how this setting can affect your display, refer to Video Source Output Examples for Multiple Monitors on page B-1.
Monitor 2 VSX 5000 VSX 6000 VSX 6000A VSX 7000 VSX 7000s VSX 7000e VSX 8000	Select the video source(s) to display on Monitor 2. For more information about how this setting can affect your display, refer to Video Source Output Examples for Multiple Monitors on page B-1.

Setting	Description
Visual Concert VGA Out VSX 5000 VSX 6000 VSX 6000A VSX 7000 VSX 7000s	Specifies whether to show content on the Visual Concert™ VSX display.
VGA Out VSX 7000e VSX 8000	Specifies whether to show content on the display connected to the system's VGA output.
VCR Record Source VSX 7000s VSX 7000e VSX 8000	Specifies the video source to be recorded to videotape or DVD. If Far is enabled, the recorded video will switch to the current far site speaker. If both Near and Far are enabled, the recorded video will switch between near and far sites depending on the current speaker. This selection is available only when you are using a single monitor.

4. Select  and configure these settings:



Setting	Description
VCR VSX 7000s VSX 7000e VSX 8000	Specifies the VCR/DVD Player output format: <ul style="list-style-type: none"> • S-Video — Select if you have a VCR or DVD player connected to the system's S-Video output using an S-Video cable. • Composite — Select if you have a VCR or DVD player connected to the system output using a composite video cable.
PIP	Specifies PIP (Picture-in-Picture) behavior: <ul style="list-style-type: none"> • Camera — The PIP window is displayed when the call is first connected and when a user moves the camera, uses presets, or switches to a different camera source. • On — The PIP window stays on for the duration of the call. • Off — The PIP window is not displayed during the call. • Auto — The PIP window is displayed when a user picks up the remote. <p>Note: PIP settings are also available in the User Settings screen. Users can turn the PIP on or off and change its location on the screen using  PIP on the remote control.</p>

Setting	Description
<p>Zoom Video to Fit Screen</p> <p>VSX 5000 VSX 6000 VSX 6000A VSX 7000 VSX 7000s VSX 7000e VSX 8000</p>	<p>Specifies whether the video image is displayed full screen on a wide-screen monitor.</p> <p>If this setting is enabled, video is shown full screen with a portion of the top and bottom clipped off. If this setting is disabled, video is centered with black margins on each side.</p> <p>This setting applies to either Monitor 1 or Monitor 2, if they are set to 16:9. This setting does not apply if Dual Monitor Emulation is enabled.</p>
<p>Display Icons in a Call</p>	<p>Specifies whether to display all on-screen graphics, including icons and help text, during calls.</p>
<p>Snapshot Timeout</p>	<p>Lets you choose whether to have slides and snapshots time out, after a period of four minutes.</p>
<p>Dual Monitor Emulation</p>	<p>Specifies whether the system can show multiple views on a single display. If content is being viewed, different views can be displayed by pressing  PIP on the remote control.</p> <p>For more information, refer to Using Dual Monitor Emulation on page 3-7.</p>

Using Dual Monitor Emulation

Dual Monitor Emulation is designed for rooms or offices with one monitor only. Users see both near and far sites on one monitor in two different views. During presentations, users see content *and* the near and far sites. What you see during a call can depend on factors such as the VSX system monitor configuration, the number of sites in the call, and whether content is being shared.

Examples of Dual Monitor Emulation

	Far site	Near site
<p>Call connects</p> <p>Near and far site are the same size and appear side by side.</p>		
<p>Near site presses PIP</p> <p>Size of far site window increases.</p>		
<p>Near site presents to far site</p> <p>Content, near site, and far site are displayed in dual monitor emulation mode.</p>		

Using Dual Monitor Emulation in a Call

During calls using Dual Monitor Emulation without content, users can press the PIP button on the remote control to scroll through the following screen layouts:





1. Near and far sites, same size, side by side
2. Far site big, near site small
3. Near site big, far site small
4. Near site, full screen
5. Far site, full screen

The last layout viewed is used for the next call.

Configuring Multipoint Viewing Modes

To configure multipoint viewing modes:

1. Go to **System > Admin Settings > Monitors > Multipoint Setup**.
2. Configure these settings:

Setting	Description
Auto Answer Multipoint Video VSX 3000 VSX 3000A VSX 7000 VSX 7000s VSX 7000e VSX 8000	Specifies whether to accept incoming multipoint calls automatically.
Multipoint Mode VSX 3000 VSX 3000A VSX 7000 VSX 7000s VSX 7000e VSX 8000	<div style="display: flex; align-items: flex-start;"> <div style="margin-right: 10px;">  </div> <div> <p>Auto — The view switches between Full Screen mode and Discussion mode, depending on the interaction between the sites. If multiple sites are talking at the same time, Discussion mode is used. If one site is talking uninterrupted for at least 15 seconds, the speaker appears full screen.</p> </div> </div> <div style="display: flex; align-items: flex-start; margin-top: 10px;"> <div style="margin-right: 10px;">  </div> <div> <p>Discussion — All sites are displayed at the same time in separate windows on the display. This mode is also called continuous presence.</p> </div> </div> <div style="display: flex; align-items: flex-start; margin-top: 10px;"> <div style="margin-right: 10px;">  </div> <div> <p>Presentation — The speaker sees all other sites in discussion mode while the other sites see the speaker in full screen mode.</p> </div> </div> <div style="display: flex; align-items: flex-start; margin-top: 10px;"> <div style="margin-right: 10px;">  </div> <div> <p>Full Screen — The site that is speaking is shown in full screen to all other sites. This mode is also called voice-activated switching.</p> </div> </div>

What you see during a multipoint call can depend on factors such as the VSX system monitor configuration, the number of sites in the call, whether content is shared, and whether dual monitor emulation is used.

- The VSX 8000 supports up to six sites in a multipoint call. During calls that include more than four sites with Discussion or Presentation mode selected, the VSX 8000 displays the site that is hosting the conference along with the last three sites where people spoke.
- When the system that is streaming a multipoint call is also hosting the conference, the stream displays the current speaker, no matter how **Multipoint Mode** is configured. When the system that is streaming a multipoint call is not hosting the conference, the stream displays the view from the streaming system.



Points to note about Discussion mode:

- To correctly display Discussion mode, you must select both **Near** and **Far** video sources for Monitor 1.
- To correctly display Discussion mode for multipoint calls with three sites shown on two monitors, you must select both **Near** and **Far** video sources for Monitor 1, and clear **Far** for Monitor 2.
- You cannot display Discussion mode on Monitor 2.

To select video sources, use the configuration settings described on page 3-4.

Adjusting the Monitor's Color Balance, Sharpness, and Brightness

In most cases, the monitor you connect to your system may be set to a configuration that is appropriate for video conferencing applications. Depending on your environment and model of monitor, however, the video may exhibit one of these problems:

- Picture is too dark or too bright
- Colors appear faded
- Picture has too much of one color — for example, the picture may appear greenish
- Picture has blocky or softened edge detail

If you notice any of these problems, adjust the monitor until the display seems acceptable. Use the video diagnostics test as described in the following steps, or purchase a calibration program DVD tool to help you fine-tune the display settings.

To adjust the monitor for natural color:

1. Go to **System > Diagnostics > Video**.
2. Select the color bars icon to display the color bar test screen.
3. Adjust the color using the monitor's controls for color, contrast, and brightness. Your monitor may also have controls for tint and temperature.

The colors from left to right should be white, yellow, cyan, green, magenta, red, and blue. Make sure that the white is not tinted red, green, or blue, and that the red is not tinted pink or orange.

4. When the colors look right on the test screen, press  **Near** on the remote control to stop the color bars test and show video of the room.
5. If the color appears natural, you do not need to make further adjustments.

If the color still needs adjustment, use the monitor's controls to make small adjustments until the picture appears natural.

Preventing Monitor Burn-In

Monitors and VSX systems provide display settings to help prevent image burn-in. Plasma televisions can be particularly vulnerable to this problem. Refer to your monitor's documentation or manufacturer for specific recommendations and instructions. The following guidelines help prevent image burn-in:

- Set **Output upon Screen Saver Activation** to **Black**.
- Use the monitor's burn-in prevention features, if available.
- Ensure that static images are not displayed for long periods.
- Set the **Screen Saver Wait Time** to 3 minutes or less.
- To keep the screen clear of static images during a call, disable the following settings:
 - **Display Icons in a Call** described on page [3-6](#)
 - **Display Time in Call** described on page [6-2](#)
 - **Far Site Name Display** described on page [6-2](#)
- Be aware that meetings that last more than an hour can have the same effect as a static image.
- Consider decreasing the monitor's sharpness, brightness, and contrast settings if they are set to their maximum values.

Connecting Cameras

Connecting Document Cameras to Desktop Systems

You can connect a document camera to show detailed close-up views of printed documents or other small items. The VSX 3000 and VSX 3000A systems provide one composite video input.

Refer to the system setup sheet for information about connecting a document camera.

Connecting Cameras to Set-top Systems

VSX 7000 and VSX 7000s systems provide an S-Video input for a second camera. You can use the RS-232 serial port on the VSX 7000 or VSX 7000s system for camera control.

You can connect a camera to the VCR video input on the VSX 5000, VSX 6000, or VSX 6000A system. On the VSX 6000 and VSX 6000A systems, the video input is for a composite video signal. VSX 5000, VSX 6000, and VSX 6000A systems do not provide pan/tilt/zoom (PTZ) control for a second camera.

Refer to your system's setup sheet for connection details. Refer to the release notes for a list of supported PTZ cameras.

Connecting Cameras to Component Systems

If you have a component system, you need to connect a camera to the system so that people at other sites can see your site. Refer to your system's setup sheet for connection details.

The component systems provide S-video connections for two cameras. The VSX 8000 system provides the S-video signal to the main camera through BNC connectors. Refer to the release notes for a list of supported PTZ cameras.

You can configure a VSX 7000e or VSX 8000 system with a Polycom PowerCam™ Plus to track to the speaker's voice or to camera presets.



Points to note about automatic camera tracking with the PowerCam Plus camera:





- Automatic camera tracking works best at distances of 15 feet (4.6 m) or less.
- Automatic camera tracking works best if you face the camera when you speak.
- Leave at least one foot (0.3 m) of space above, behind, to the right, and to the left of the camera. Echoes from nearby surfaces interfere with tracking.
- Automatic camera tracking works best in rooms with good acoustics.
- For information about user interface settings required for automatic camera tracking, refer to [Configuring Automatic Camera Tracking](#) on page 3-14.

Configuring Camera Settings and Video Quality Options

To configure camera and video settings:

1. Go to **System > Admin Settings > Cameras**.
2. Configure these settings on the Cameras screen:

Setting	Description
Far Control of Near Camera VSX 5000 VSX 6000 VSX 6000A VSX 7000 VSX 7000s VSX 7000e VSX 8000	Specifies whether the far site can control the position of the near-site camera. When this option is selected, a user at the far site can control the framing and angle of the camera for the best view of the near site.
Backlight Compensation	Specifies whether to have the camera automatically adjust for a light background. Backlight compensation is best used in situations where the subject appears darker than the background.
Camera Brightness VSX 3000 VSX 3000A VSX 5000	Specifies how much light is let into the camera's iris. A low number allows in less light; a high number allows in more light.
Primary Camera	Specifies which camera is the main camera.
Camera Direction VSX 5000 VSX 6000 VSX 6000A VSX 7000 VSX 7000s VSX 7000e VSX 8000	Specifies the direction the camera moves when using the arrow buttons on the remote control.
Power Frequency VSX 3000 VSX 3000A VSX 5000	Specifies the frequency of the electrical power used for the camera. <ul style="list-style-type: none"> • 50 Hz—Select if you have a PAL system. • 60 Hz—Select if you have an NTSC system.
VCR/DVD Audio Out Always On VSX 7000s VSX 7000e VSX 8000	Allows you to record a call using one VCR or DVD, while playing recorded content into the call from a second VCR or DVD. Do not select this setting if you have only one VCR or DVD player connected.



3. Select  to go to the Camera Settings screen:
 - Specify the name, icon, and format for each video source.
 - VSX 6000, VSX 7000, VSX 7000s, VSX 7000e, VSX 8000: Specify whether secondary camera sources are **People** or **Content**. Camera sources specified as **Content** are sent at a higher resolution and lower frame rate.
4. Select  to go to the Video Quality screen.
5. Select **Motion** or **Sharpness** for the video inputs:
 - **Motion** – This setting is for showing people or other video with motion.
 - **Sharpness** – The picture will be sharp and clear, but motion will not be smooth. Choose this setting for document cameras. Sharpness is available in point-to-point H.263 calls only.
6. Set **Pro-Motion Video** to specify when to use Pro-Motion for video inputs set for motion. Pro-Motion provides 50/60 fields per second interlaced video for TV-like quality at higher bandwidths.
 - VSX 3000 and VSX 3000A systems send Pro-Motion video for the DVD/VCR input only.
 - VSX 5000, VSX 6000, and VSX 6000A systems can receive Pro-Motion video but cannot transmit it.
7. Select  to go to the Camera Calibration screen. Only VSX 7000e and VSX 8000 systems with a PowerCam Plus camera can be calibrated for automatic camera tracking. Follow the instructions on the screen to calibrate the camera for automatic camera tracking if it consistently moves too far in one direction when tracking is enabled. Press  **Near** on the remote control so that you can zoom the camera in on your mouth.



For the best calibration results, make sure the camera and system are set up as described in [Configuring Automatic Camera Tracking](#) on page 3-14 and [Connecting Cameras to Component Systems](#) on page 3-11.

To configure a second camera:

1. Go to **System > Admin Settings > Cameras**.
2. VSX 5000, VSX 6000A, VSX 7000, VSX 7000s, VSX 7000e, VSX 8000: Designate this camera as the primary camera, if desired.
3. VSX 5000, VSX 6000A, VSX 7000, VSX 7000s, VSX 7000e, VSX 8000: Set **Camera Direction** to specify which way the camera moves when you control it with the remote control.

4. Select  to go to the Camera Settings screen:
 - VSX 5000, VSX 7000, VSX 7000s, VSX 7000e, VSX 8000: Specify the name, icon, and format for the camera. If you used an RCA to mini-DIN adapter to connect the camera cable, change the **Video Format** to **Composite**.
 - VSX 6000, VSX 7000, VSX 7000s, VSX 7000e, VSX 8000: Specify whether secondary camera sources are **People** or **Content**. Camera sources specified as **Content** are sent at a higher resolution and lower frame rate.
5. Select  to go to the Video Quality screen.
6. Select **Motion** or **Sharpness**:
 - **Motion** – This setting is for showing people or video with motion.
 - **Sharpness** – The picture will be sharp and clear, but motion will not be smooth. Choose this setting for still images.
7. Go to **System > Admin Settings > General Settings > Serial Port**.
8. VSX 7000, VSX 7000s, VSX 7000e, VSX 8000: If the camera is a PTZ camera, set **RS-232 Mode** to **Sony PTZ** camera control and specify which camera is associated with this port.

Configuring Automatic Camera Tracking

You can configure a VSX 7000e or VSX 8000 with a Polycom PowerCam Plus to track to the speaker's voice or to camera presets. During a call, users can press  **Auto** on the remote control to toggle between Automatic Camera Tracking, Automatic Camera Tracking to Presets, and Automatic Camera Tracking Off.

When Automatic Camera Tracking to Presets is enabled and no one speaks for 30 seconds, the camera automatically moves to preset 0. When Automatic Camera Tracking is enabled and no one speaks for 30 seconds, the camera automatically moves to a position to include all of the people who have spoken.

If the camera consistently moves too far in one direction when tracking is enabled, follow the instructions on the Camera Calibration screen to calibrate the camera for better tracking.



Points to note about using automatic camera tracking:

- You must have a VSX 7000e or VSX 8000 with a Polycom PowerCam Plus camera.
- If you are using Polycom microphones, make sure they are properly connected and unmuted, and that the **Enable Polycom Microphones** and **Echo Canceller** settings are selected.
- If you are using a Polycom Vortex®, disable the **Enable Polycom Microphones** and **Echo Canceller** settings.
- Disable the **Enable Polycom StereoSurround™** setting.
- Automatic Camera Tracking and Automatic Camera Tracking to Presets remain enabled after a system restart.

For more information about setting up the PowerCam Plus for automatic camera tracking, refer to the section [Connecting Cameras to Component Systems](#) on page 3-11.

Configuring Camera Presets



Camera presets are stored camera positions that you can create ahead of time or during a call.

Presets allow users to:

- Automatically point a camera at pre-defined locations in a room.
- Select a video source such as a VCR or DVD player, a document camera, or an auxiliary camera.

If your system's main camera supports electronic pan, tilt, and zoom movement, you can create up to 100 preset camera positions for the near site. Each preset stores the camera number, its zoom level, and the direction it points (if appropriate). Near-site presets are available for VSX set-top and component systems. They remain in effect until you delete or change them.

To store a preset:

1. If you are in a call, press  **Near** or  **Far** on the remote control to choose a near-site or far-site camera or other video source.
2. If you selected a camera that supports electronic pan, tilt, and zoom, you can adjust the camera's position:
 - Press the arrow buttons on the remote control to move the camera up, down, to the left, or to the right.
 - Press  **Zoom** to zoom the camera out or in.

3. Press  **Preset** on the remote control.

4. Press and hold a number to store the preset position.

To store a double-digit preset (10-99), hold the second number down.

Any existing preset stored at the number you enter is replaced.

If Automatic Camera Tracking to Presets will be used during calls, set preset 0 to a wide shot of the room. When Automatic Camera Tracking to Presets is enabled and no one speaks for 30 seconds, the camera automatically moves to preset 0.

To delete all presets:

1. If a call is connected, press  **Near** to choose a near-site video source.

2. Press  **Preset** on the remote control.

3. Press  **Delete** to delete all presets.

Microphones and Speakers

Connecting Polycom Microphones or a SoundStation VTX 1000

For best audio, place the microphone or SoundStation VTX 1000:

- On a hard, flat surface (table, wall, or ceiling) away from obstructions, so the sound will be directed into the microphone elements properly.
- Near the people closest to the monitor.
- In large conference rooms, you may need more than one microphone. If you are using a SoundStation VTX 1000, you may need to connect its extension microphones.

Connecting Polycom Microphones to Set-Top or Component Systems

To pick up audio from your site, you must connect a microphone or a SoundStation VTX 1000 conference phone to the system. Refer to your system's setup sheet for connection details.



You can use a Polycom microphone or a SoundStation VTX 1000 with the system, but the two may not be used together.

You may place the microphones on the table, or you may mount them to the ceiling. A ceiling mount kit is available for Polycom microphones.

You can connect two additional Polycom microphones to a VSX 7000, VSX 7000s, or component VSX system.

The following diagram shows microphone connection options for VSX set-top systems.

Any set-top or component system

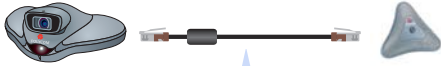

VSX 7000 or a component system

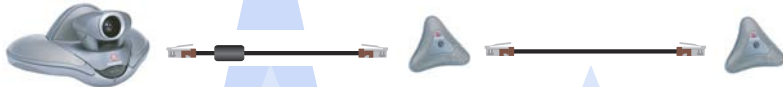

VSX 7000 or a component system



50 ft (15 m)
2457-20910-050
or 30 ft (9 m)
2457-20910-001

















30 ft (9 m)
2457-20910-003
or 10 ft (3 m)
2457-20910-002

30 ft (9 m)
2457-20910-003
or 10 ft (3 m)
2457-20910-002

**The ferrite bead
must be at the
end connected
to the system.**

Placing Polycom Microphones to Send Stereo from Your Site

If you use a single microphone to send stereo, one microphone element picks up audio from the left side of the room, one picks up the right side of the room, and the third is not used.

Stereo using one microphone	Stereo using two microphones	Stereo using three microphones
<p>not used</p> <p>left  right</p>	<p>left  right </p> <p>left  right </p>	<p>left  not used  right </p> <p>left  left  right  right </p>
	<p>not used</p> <p>left  right</p> <p>not used</p> <p>left  right</p>	<p>not used</p> <p>left  right</p> <p>not used</p> <p>left  right</p> <p>not used</p> <p>left  right</p>

The following illustrations show microphone placement for different room layouts.

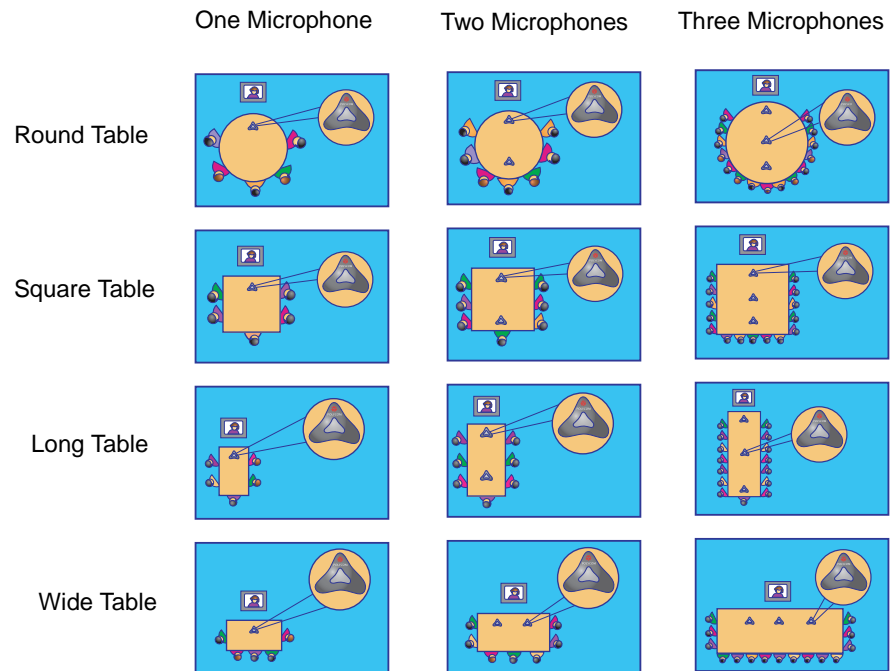

Place microphones so that:

- The logo on each microphone points toward the monitor.
- The microphone closest to the monitor is parallel with, or in front of, the person nearest the monitor.

After you power on the system, you will need to configure the system to send stereo as described in [StereoSurround Settings](#) on page 4-14.

Connecting a SoundStation VTX 1000 to a Set-top or Component System

You can connect a SoundStation VTX 1000 conference phone in place of a Polycom microphone. In large rooms, you may also need to use the extension microphones provided with the SoundStation VTX 1000. Refer to your system's setup sheet and the setup sheet provided with the SoundStation VTX 1000 for connection details.

You can use a Polycom microphone or a SoundStation VTX 1000 with the system, but the two may not be used together.

To take advantage of the latest integration features, the VSX system requires version 8.0 or later software and the SoundStation VTX 1000 requires version 1.5 or later software.

Placing a SoundStation VTX 1000 Phone to Send Stereo from Your Site

The VSX set-top and component systems allow you to send stereo using a SoundStation VTX 1000 conference phone, with or without extension microphones.

When StereoSurround is enabled, one microphone element picks up audio from the left side of the room, one picks up the right side of the room, and the third is disabled, as shown in the following diagram.

Stereo using a SoundStation VTX 1000

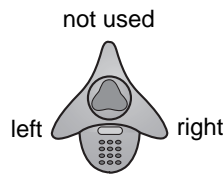

Stereo using a SoundStation VTX 1000 with extension microphones

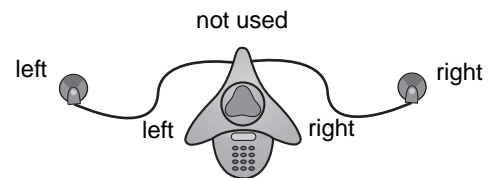

The following illustrations show how to place the SoundStation VTX 1000 conference phone for different room layouts.

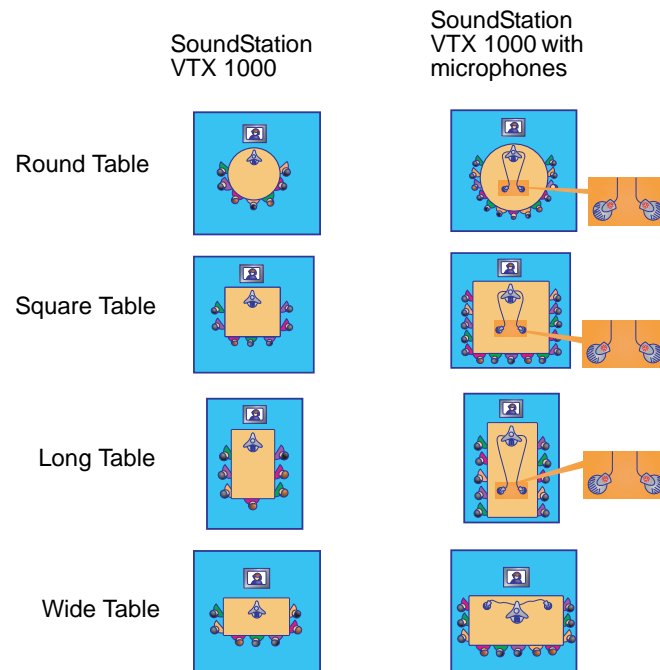

Position the SoundStation VTX 1000 so that:

- The keypad should be pointing away from the monitor.
- The SoundStation VTX 1000 should be parallel with, or in front of, the person nearest the monitor.

Connecting Non-Polycom Microphones to a Set-top System

In addition to the Polycom microphone or SoundStation VTX 1000 conference phone, you can connect other powered microphones directly to the system's audio inputs.

Connecting Non-Polycom Microphones or a Mixer

You can connect two powered microphones directly to the VSX 8000 system, or you can connect several studio-type microphones to the VSX 8000 system through an audio mixer.

Connecting a Polycom Vortex mixer to VSX set-top or component systems provides flexibility in audio set-up. For example, it allows you to provide a microphone for each call participant in a boardroom.

The VSX 8000 is designed to work with Polycom Vortex mixers. For top performance, you need Vortex firmware 2.5.2 or later, Conference Composer™ version 2.7.0 or later, and VSX system software version 8.5 or later. Refer to your system's setup sheet for connection details.

Connecting Speakers

Connecting Speakers or Headphones to Desktop Systems

You can connect desktop speakers to provide better audio for the VSX 3000 or VSX 3000A system if you place it in a large room, or you can connect headphones to listen to calls privately. The system's speaker connector is on the system's right side panel, and the headphone connector is on the front of the system.

Refer to your system's setup sheet for connection details.

Connecting Speakers to Set-top Systems

If you have a VSX 5000, you must connect speakers to play audio from the far site. You can use the speakers built into the main monitor.

The other set-top systems have built-in speakers. You can connect an external speaker system such as the Polycom StereoSurround kit to provide more volume and richer sound in large rooms. Refer to your system's setup sheet for connection details.

Connecting Speakers to Component Systems

You must connect at least one speaker to play audio from the far site. You can use the speakers built into the main monitor, or you can connect an external speaker system such as the Polycom StereoSurround kit to provide more volume and richer sound in large rooms. Refer to your system's setup sheet for connection details.

Placing Speakers to Play Stereo from Far Sites

The Polycom StereoSurround kit is designed for use with VSX systems. It includes two speakers and a subwoofer. If you do not choose to connect external speakers, you can use your monitor's speakers to receive stereo.

You cannot receive stereo with a set-top VSX system using the system's built-in speaker.

When you set up the system for StereoSurround, the left microphone and speaker should be on the left from the local room perspective. Place the speaker connected to the audio system's right channel on the right side of the system, and the other speaker on the left side. The system reverses the left and right channels for the far site, as shown in the following illustration. This ensures that the sound comes from the appropriate side of the room.

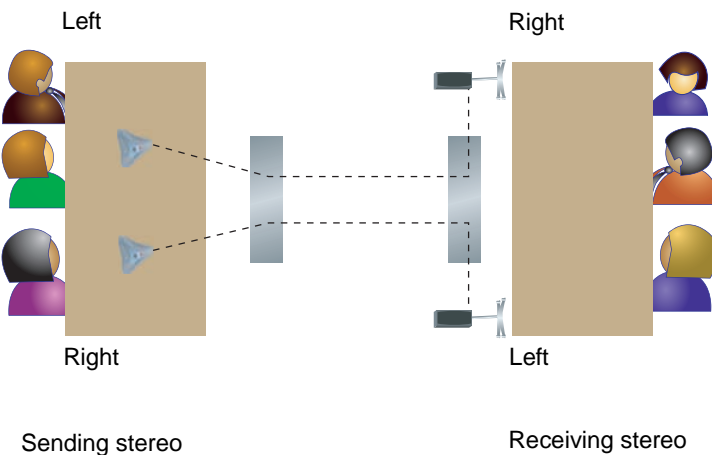

For best results, place the speakers about 60° apart as seen from the center of the conference table.

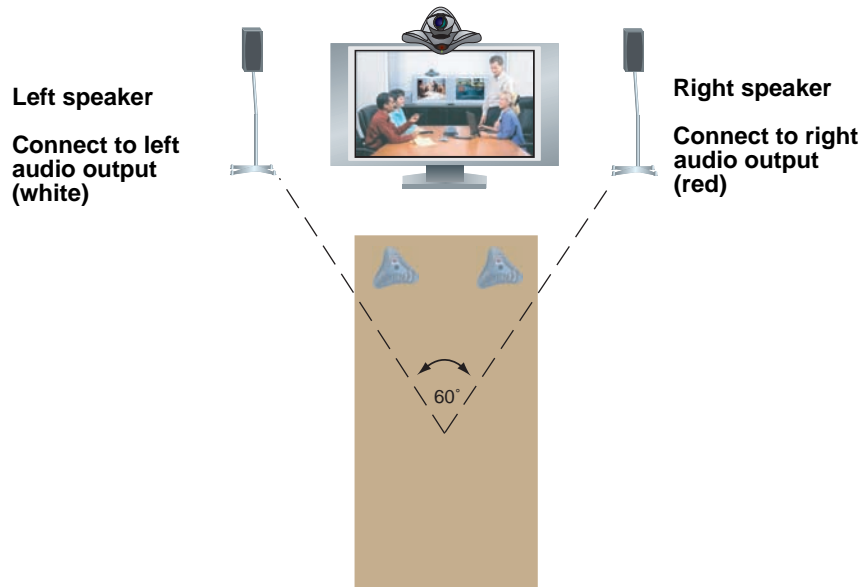

If you are using a subwoofer, place it beside a wall or in a corner near the speakers.

Setting the Speaker Volume

To set the volume of an external speaker system:

1. Go to **System > Diagnostics > Audio > Speaker Test**.
2. Start the speaker test.
3. Adjust the volume of the speaker system. From the center of the room the test tone should be as loud as a person speaking loudly, about 80-90 dBA on a sound pressure level meter.

Configuring Audio Settings

General Audio Settings

To configure general audio settings:

1. Go to **System > Admin Settings > Audio**.

The Audio Settings screen, where you choose Audio Settings or Stereo Settings, is not present on a VSX 3000 or VSX 3000A. It is available on a set-top or component system after you have enabled the Polycom StereoSurround option.

2. Configure these settings on the Audio Settings screen:

Setting	Description
Sound Effects Volume	Sets the volume level of the ring tone and user alert tones.
Incoming Video Call	Specifies the ring tone used for incoming calls.
User Alert Tones	Specifies the tone used for user alerts.
Mute Auto Answer Calls	Specifies whether to mute incoming calls. Incoming calls are muted by default until you press the mute on the microphone or on the remote control.
Enable Internal Ringer VSX 3000 VSX 3000A	Specifies an additional ring tone when receiving an incoming call. The internal ringer is built into the system and alerts you to incoming calls.
Enable Polycom Microphones	<p>Specifies whether integrated and attached Polycom microphones are enabled. You can disable this option to turn off:</p> <ul style="list-style-type: none"> • VSX 3000 or VSX 3000A system's integrated microphone • VSX 6000, VSX 6000A, VSX 7000, VSX 7000e and VSX 8000 microphones • SoundStation VTX 1000 integrated microphones • SoundStation VTX 1000 extended microphones <p>Disable this setting in the following situations:</p> <ul style="list-style-type: none"> • You have a VSX system integrated with both a Vortex mixer and a SoundStation VTX 1000 conference phone. • You have an external handset, headset, or lapel microphone attached to a VSX system line input. <p>This option is automatically disabled if a line input is set to Audio Mixer, echo cancellation is enabled on a line set for Audio Mixer, and stereo is enabled.</p>

Setting	Description
Enable Polycom StereoSurround	<p>Specifies that Polycom StereoSurround is used for all calls. To send or receive stereo audio, make sure your VSX system is set up as described in Connecting Polycom Microphones to Set-Top or Component Systems on page 4-1 and Connecting Speakers on page 4-6. Your system can receive stereo audio even when it cannot send stereo.</p> <p>When you use an audio mixer with Echo Canceller enabled, the stereo input is from the mixer only and the Polycom microphones are disabled. If Echo Canceller is disabled, the Polycom microphones are enabled and are added to the audio from the mixer.</p> <p>VSX 7000 and VSX 7000e: When you use an audio mixer with stereo enabled, the microphones are disabled.</p> <p>VSX 8000: When you use the Balanced In echo canceller with stereo enabled, the microphones are disabled.</p>
Enable Live Music Mode	<p>Specifies whether the system transmits audio using a configuration that best reproduces live music picked up by microphones.</p> <p>Note: Noise suppression and automatic gain control are disabled when this setting is enabled.</p>

3. Select  and enter VCR/DVD settings for the VSX 7000e system:

Setting	Description
VCR/DVD In Level	Sets the volume at which the VCR/DVD player plays, relative to other audio from the system.
VCR/DVD Out Level	Sets the volume at which the call is recorded.
VCR/DVD Audio Out Always On	<p>Allows you to record a call using one VCR or DVD, while playing recorded content into the call from a second VCR or DVD.</p> <p>Do not select this setting if you have only one VCR or DVD player connected. If this setting is disabled, the VCR audio output is disabled when VCR is the selected camera source.</p>

4. Select  and enter line input settings:

Setting	Description
Line Input (Red and White) VSX 3000 VSX 3000A VSX 5000 VSX 6000 VSX 6000A VSX 7000	Specifies how audio is heard from equipment you connect to the audio input connectors on the back of the system. <ul style="list-style-type: none"> • Audio Mixer—Audio input is heard at the far site only, not at the near site. Use this setting for microphone signals. • VCR—Audio input is heard at both the far site and near site. This setting requires that the video source is set to VCR; otherwise, no audio is heard. Select VCR when playing a VCR/DVD into the system.
Line Input VSX 7000e	Specifies the type of equipment that is connected to the audio input connectors. Choose Audio Mixer if connected to a mixer. Select Visual Concert when sharing content using an ImageShare™ II, Visual Concert VSX, or laptop connected directly to the system.
Input Type VSX 8000	Specifies the type of equipment that is connected to the balanced audio inputs. Choose Line Input unless you have connected microphones directly to the balanced audio inputs.
Level	Sets the volume level for the line with which it is associated. For a VCR/DVD player, sets the playback volume of the VCR/DVD player relative to other audio from the system.
Echo Canceller	Lets you specify whether to use the system's built-in echo canceller. Do not enable this option if you have connected a Polycom Vortex mixer. This option is not available on some systems when the line input type is set to VCR.
Line Out 2 Phono VSX 7000e	Specifies whether volume for a device connected to the audio line out connectors is variable or fixed. <ul style="list-style-type: none"> • Variable—Allows users to set the volume with the remote control. • Fixed—Sets the volume to the Audio Level specified in the system interface.
Enable Phantom Power VSX 8000	Allows the system to supply power to microphones connected directly to the balanced audio inputs. Note: This selection is only available when you set Input Type to Microphone .

Setting	Description
VCR/DVD In Level VSX 7000s	Sets the playback volume of the VCR/DVD player relative to other audio from the system.
VCR/DVD Out Level VSX 7000s	Sets the volume at which the call is recorded.
VCR/DVD Audio Out Always On VSX 7000s	Allows you to record a call using one VCR or DVD, while playing recorded content into the call from a second VCR or DVD. Do not select this setting if you have only one VCR or DVD player connected. If this setting is disabled, the VCR audio output is disabled when VCR is the selected camera source.

5. Select  and enter audio output settings for the VSX 8000 system:

Setting	Description
Balanced Out (600 ohms)	Specifies whether volume for a device connected to the balanced audio output connectors is variable or fixed. <ul style="list-style-type: none"> • Variable—Allows users to set the volume with the remote control. • Fixed—Sets the volume to the Audio Level specified in the system interface.
Line Out 2 Phono	Specifies whether volume for a device connected to the audio line out connectors is variable or fixed. <ul style="list-style-type: none"> • Variable—Allows users to set the volume with the remote control. • Fixed—Sets the volume to the Audio Level specified in the system interface.

6. Select  and enter VCR/DVD settings for the VSX 8000 system:

Setting	Description
Line Input (Red) Line Input (White)	Select VCR when playing a VCR into the system. Select Visual Concert when sharing content using an ImageShare II, Visual Concert VSX, or laptop connected directly to the system.
Level	Sets the playback volume of the VCR/DVD player relative to other audio from the system.

Setting	Description
VCR/DVD Out Level	Sets the volume at which the call is recorded.
VCR/DVD Audio Out Always On	Allows you to record a call using one VCR or DVD, while playing recorded content into the call from a second VCR or DVD. Do not select this setting if you have only one VCR or DVD player connected. If this setting is disabled, the VCR audio output is disabled when VCR is the selected camera source.

7. Select  and enter speaker settings:

Setting	Description
Master Audio Volume	Sets the volume level for audio from the far site.
Midrange Speaker VSX 6000 VSX 6000A VSX 7000 VSX 7000s	Specifies whether to use the system's built-in midrange speaker. You may prefer to turn off the midrange speaker if you connect the audio output to Monitor 1 or if you connect an external speaker system.
Subwoofer Speaker VSX 7000 VSX 7000s	Specifies whether to use the system's subwoofer. You may prefer to turn off the subwoofer speaker if you connect the audio output to Monitor 1. The system will not operate if you disconnect the subwoofer.
Subwoofer Level VSX 7000 VSX 7000s	Sets the volume level for the subwoofer without changing the master audio volume.
Bass	Sets the volume level for the lower frequencies without changing the master audio volume.
Treble	Sets the volume level for the higher frequencies without changing the master audio volume.
Line Outputs VSX 6000 VSX 6000A VSX 7000	Specifies how the audio output behaves. The default selection, Monitor - Far Site Audio , supplies audio to the Monitor 1 audio outputs only when the system is receiving audio from the far site. If you have connected a VCR to record the conference, select VCR - Far and Near Audio to supply audio from both the far site and the system's microphones to the VCR.

StereoSurround Settings

To send or receive stereo audio, make sure your VSX system equipment is set up as described in [Connecting Polycom Microphones to Set-Top or Component Systems](#) on page 4-1 and [Connecting Speakers](#) on page 4-6. Then configure the system to use Polycom StereoSurround, test the system configuration, and place a test call.

If you are in a call with a far site that is sending audio in stereo mode, you can receive in stereo. In multipoint calls where some sites can send and receive stereo and some sites cannot, any site that is set up to send or receive stereo will be able to do so.



Points to note about StereoSurround:

- Camera tracking is disabled when you enable StereoSurround.
- If StereoSurround is enabled on a VSX 6000 or VSX 7000, the system cannot record audio from a call.

To configure systems to send and receive Polycom StereoSurround:

1. Go to **System > Admin Settings > Audio**.
Set **Enable Polycom StereoSurround**.
2. VSX 7000, VSX 7000s: Go to **System > Admin Settings > Audio > Audio Settings > Next > Next**.
Set **Subwoofer Speaker** to **Off**.

To test your stereo configuration:

1. Go to **System > Admin Settings > Audio > Stereo Settings > Next**.
Specify the **Table Style** and make sure the microphones are positioned as shown.
Also refer to [Placing Polycom Microphones to Send Stereo from Your Site](#) on page 4-3 and [Placing a SoundStation VTX 1000 Phone to Send Stereo from Your Site](#) on page 4-5.
2. Go to **System > Admin Settings > Audio > Stereo Settings**.
Gently blow on the left leg and right leg of each Polycom microphone while watching the Left and Right meters to identify the left and right inputs. Select **Swap** if necessary.

3. Go to **System > Admin Settings > Audio > Stereo Settings > Next > Next**.

Test the speakers to check volume and verify that audio cables are connected. If the system is in a call, the far site hears the tone.

Exchange the right and left speakers if they are reversed.

Adjust the volume control on your external audio amplifier so that the test tone sounds as loud as a person speaking in the room. If you are using a Sound Pressure Level (SPL) meter, it should measure about 75 dBA in the middle of the room.

To make a test call in stereo:

- Select **Polycom Austin Stereo** from the directory, or enter `stereo.polycom.com` in the dialing field and press  **Call** on the remote control.

The Polycom Austin Stereo site demonstrates the stereo feature with an entertaining and informative presentation.

Settings for Connecting to a Polycom Vortex Mixer

To configure VSX systems to use a Polycom Vortex mixer:

1. Go to **System > Admin Settings > Audio > Audio Settings**.
Disable the **Enable Polycom Microphones** setting if you have integrated both a Vortex and a SoundStation VTX 1000 conference phone with the VSX system.
2. VSX 5000, VSX 7000, VSX 7000e: Go to **System > Admin Settings > Audio > Audio Settings > Next**. Configure **Balanced In**:
Set **Input type** to **Line Input**.
Disable **Echo Canceller**.
3. VSX 8000: Go to **System > Admin Settings > Audio > Audio Settings > Next**. Configure **Audio I/O**:
Set **Line Input** to **Audio Mixer**.
Disable **Echo Canceller**.
4. Go to **System > Admin Settings > General Settings > Serial Ports**.
Set **RS-232 Mode** to **Vortex Mixer** for the appropriate port.

Refer to the Polycom Vortex documentation for details on configuring the mixer.

Settings for Non-Polycom Microphones

To configure the VSX system to use microphones connected directly to the RCA audio inputs:

1. Go to **System > Admin Settings > Audio > Audio Settings > Next**.
Configure **Balanced In**:

Set **Line Input** to **Audio Mixer**. (except VSX 7000s)

Enable **Echo Canceller**.

Adjust the audio **Level** if necessary. You can test this setting using the Audio Meter.

2. Go to **System > Diagnostics > Audio > Audio Meter**.

Speak into the microphones that are connected to the audio line inputs. The audio meter should peak at about 10dB for normal speech.

The Audio screen, where you choose Audio Settings or Stereo Settings, is not present unless stereo is enabled.

Settings for Microphones Connected to Balanced Audio Inputs on a VSX 8000 System

To configure the VSX 8000 system to use microphones connected directly to the balanced audio inputs:

1. Go to **System > Admin Settings > Audio > Audio Settings > Next**.
Configure **Balanced In**:

Set **Input type** to **Microphone**.

Select **Echo Canceller**.

Select **Enable Phantom Power** to supply power to microphones.

Adjust the audio **Level** if necessary. You can test this setting using the Audio Meter.

2. Go to **System > Diagnostics > Audio > Audio Meter**.

Speak into the microphones that are connected to the balanced audio inputs. The audio meter should peak at about 10dB for normal speech.

The Audio screen, where you choose Audio Settings or Stereo Settings, is not present unless stereo is enabled.

Content and Closed Captions

You can present content during calls on a TV monitor or VGA display when you use:

- A VCR or DVD player connected directly to a Polycom VSX system
- A Visual Concert VSX data collaboration unit, with any VSX set-top system
- An ImageShare II device, with any VSX component system
- People+Content IP installed on a computer, with any VSX system
- A computer connected directly to a VSX component system

For information about ordering the People+Content IP option, Visual Concert VSX unit, or ImageShare II device, please contact your Polycom distributor.

Connecting VCR/DVD

You can connect a VCR/DVD player to any VSX system to play VCR tapes or DVDs into calls.

With VSX 6000, VSX 7000, VSX 7000s, VSX 7000e, and VSX 8000 systems, you can connect a VCR or DVD player to record your video conference. Or, you can connect two VCRs or DVD players, to play material and record the call at the same time.

Configuring VCR/DVD Player Settings

Playing a Videotape or DVD

The VCR/DVD inputs are active when you select the camera source configured as VCR. The microphone inputs remain active while the VCR/DVD is playing. Call participants may wish to mute the microphones while playing VCR/DVD content.

To configure VCR/DVD audio settings for playing a videotape or DVD:

1. VSX 6000, VSX 6000A, VSX 7000, VSX 7000s: Go to **System > Admin Settings > Audio > Audio Settings > Next > Next**.
Ensure that **Midrange Speaker** is **On**.
2. VSX 3000, VSX 5000, VSX 6000A, VSX 6000A, VSX 7000, VSX 8000: Go to **System > Admin Settings > Audio > Audio Settings > Next**.
Set **Line Input(s)** to **VCR**.
Adjust the **Level** for playback volume, if necessary.
3. VSX 7000s, VSX 7000e: Go to **System > Admin Settings > Audio > Audio Settings > Next**.
Adjust the **VCR/DVD In Level** for playback volume, if necessary.

Recording a Call to Videotape or DVD

All audio from the near site and far site is recorded, along with the video source configured on the Monitors screen.

To configure VCR/DVD video settings for recording a call:

1. Go to **System > Admin Settings > Monitors > Monitors**.
Choose a setting for **Monitor 2**.
When **Monitor 2** is set to **Off**, you can specify which video sources to record.
When **Monitor 2** is enabled, the VCR or DVD player records what is shown on **Monitor 1**.
2. Go to **System > Admin Settings > Monitors > Monitors > Next**.
Select one or more sources for the **VCR Record Source**.
If you select both near and far, the VSX system automatically switches recording to the site that is talking. If you select content as a record source, it is recorded (when available) regardless of who is talking.



The VSX systems cannot be configured to simultaneously record content and show it on the VGA output of a VSX 7000e, VSX 8000, or attached Visual Concert VSX.

To configure VCR/DVD audio settings for recording a call:

1. VSX 6000, VSX 7000: Go to **System > Admin Settings > Audio > Audio Settings**.

Clear **Enable Polycom StereoSurround**. When StereoSurround is enabled on a VSX 6000 or VSX 7000, the system cannot record audio from a call.

2. VSX 6000, VSX 7000: Go to **System > Admin Settings > Audio > Audio Settings > Next > Next**.

Set **Line Outputs** to **VCR - Far and Near Audio**.

3. VSX 7000s, VSX 7000e, VSX 8000: Go to **System > Admin Settings > Audio > Audio Settings > Next > Next**.

Adjust the **VCR/DVD Out Level** if necessary.

Enable **VCR/DVD Audio Out Always On** unless you have the VCR/DVD inputs and outputs both connected to the same device to play and record.

Connecting a Visual Concert VSX to Set-top Systems

To show material from your computer, you may connect a Visual Concert VSX unit to any set-top system in the VSX series. Refer to *Setting up the Visual Concert VSX* for connection details.

The *Quick Tips for Visual Concert VSX* provides information for people using the device in meetings.



Points to note about Visual Concert VSX:

- You can use Visual Concert VSX with a Polycom microphone or a SoundStation® VTX conference phone, but not with both.
- You can use Visual Concert VSX with two Polycom microphones if you have a VSX 7000 or VSX 7000s system.
- The Visual Concert VSX and the VSX system require separate LAN connections. The Visual Concert VSX provides LAN connections for three computers, including the one sharing content.
- You can connect a VGA monitor or projector directly to the Visual Concert VSX. This lets the people at your site see content from your computer at its original resolution. The resolution may be reduced if you display it on a VGA monitor connected to the VSX system.
- You will need to set the computer's screen resolution to match the VGA output of the Visual Concert VSX.

The following diagram shows supported cable configurations for connecting a Visual Concert VSX with one microphone or two microphones.

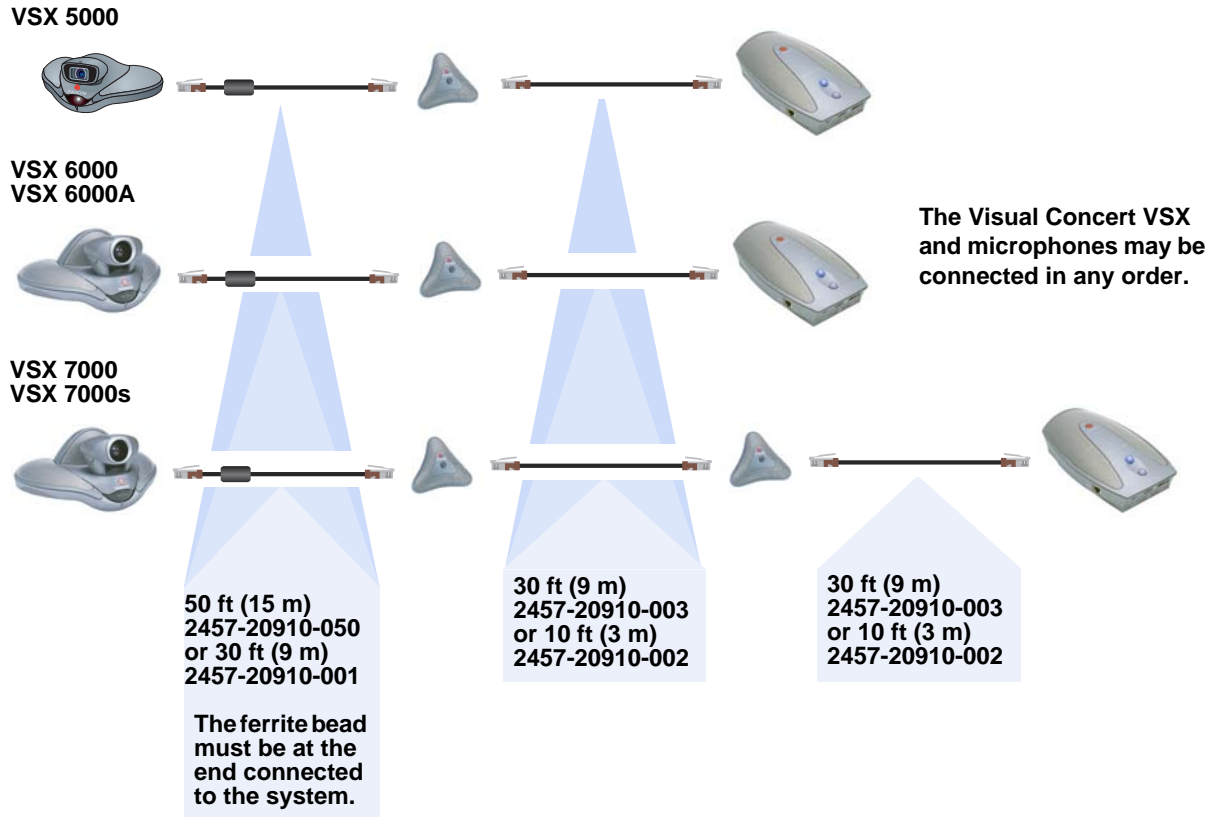

The following diagram shows supported cable configurations for connecting a Visual Concert VSX with a SoundStation VTX 1000 conference phone.

**VSX 5000
VSX 6000
VSX 6000A
VSX 7000
VSX 7000s**

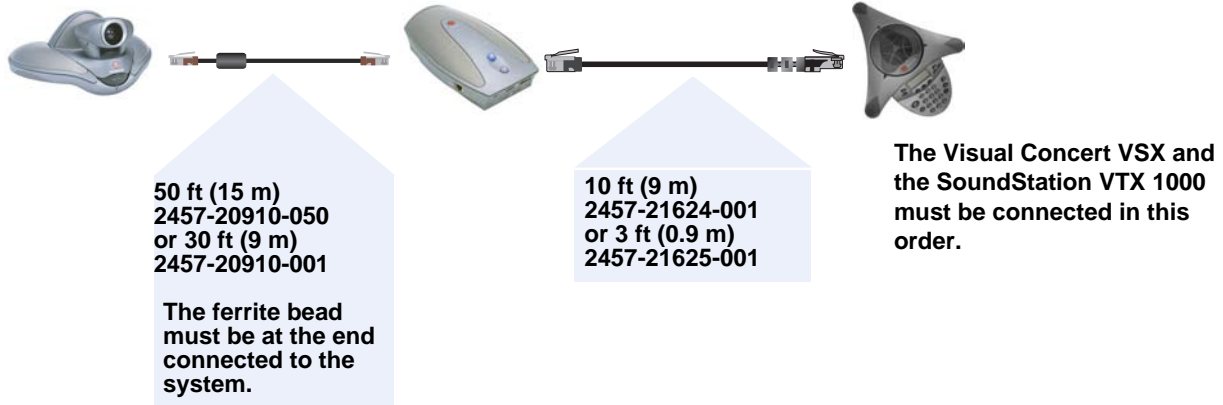

Connecting an ImageShare II to Component Systems

To show material from your computer, you may connect an ImageShare II unit to any component system in the VSX series. The ImageShare II gives you control over whether others can see what is displayed on your computer.

Refer to your system's setup sheet for connection details.

Connecting Computers to Component Systems

You can connect your computer directly to a VSX 7000e or VSX 8000 system. When you do this, other call participants see everything that you see on your computer.



Refer to your system's setup sheet for connection details.

Configuring Content Display with a Visual Concert VSX or ImageShare II

To configure the content display:

1. Go to **System > Admin Settings > Monitors > Graphics VGA**.
2. Configure these settings:

Setting	Description
VGA Output with No Graphics	Indicates that the screen appears black when there is no content to display.
VGA Resolution	Specifies the VGA resolution for your monitor. Select the maximum VGA resolution that your monitor or projector can support. Consult the user manual provided with the VGA monitor or projector for performance information.
Quality Preference	Specifies the bandwidth split for People and Content video. <ul style="list-style-type: none"> • Both — 50% Content, 50% People • Content — 90% Content, 10% People • People — 10% Content, 90% People <p>Notes: In a multipoint call, the MCU setting determines the People and Content video rates, not the system sending the content.</p> <p>This setting does not apply if automatic bandwidth adjustment is enabled using the API.</p>
Send Content When PC Connects	Specifies whether to send content automatically when the computer is connected to the Visual Concert VSX or ImageShare II. If this option is not selected, the presenter must press the Play button on the Visual Concert VSX or ImageShare II to send content to the far sites.

3. Select  if you need to adjust the VGA Input settings for systems that have built-in VGA capture capability or that use a Visual Concert VSX for VGA capture.
 - a. Select **Horizontal Position**, **Vertical Position**, or **Phase**.
 - b. Press the navigation buttons on the remote control to adjust the setting.
 - c. Press  **Back** on the remote control to accept the setting.

4. Go to **System > Admin Settings > Monitors > Monitors**.
5. Select  and select where to display **Content**.
6. Go to **System > Admin Settings > Network > Call Preference**.
7. Configure this setting:

Settings	Description
Enable H.239	Enables H.239 People+Content. Select this option if you know that H.239 is supported by the far sites you will call. Note: If callers experience issues when sharing content with other Polycom systems, clear Enable H.239 .

To configure the content audio (VSX 7000e, VSX 8000):

1. Go to **System > Admin Settings > Audio > Audio Settings**.
2. Select  two times and configure this setting:

Settings	Description
Line Input	Set Line Input to Visual Concert to share audio content.

Configuring Content Display with People+Content IP

People+Content IP is included with the VSX 8000 system and is optional for other VSX systems. It enables a presenter to show content from a computer to other sites in a video conference using only an IP network connection.

The presenter can show PowerPoint® slides, video clips, spreadsheets, or any other type of content from a computer. Supported resolutions include 640x480, 800x600, 1024x768, and 1280x1024.

Before a presenter can use a computer to show content with People+Content IP, you need to:

- Enable People+Content IP on the VSX system.
When you purchase this option, you receive a software activation key. This key allows you to enable People+Content IP on a VSX system.
- Download the People+Content IP software application from the Polycom web site to the computer(s) that the presenter will use to show content.

You don't need to change the computer resolutions and you don't need special cables or hardware, but the computer(s) must meet these requirements:

- Operating System: Windows 2000, Windows XP Home, or Windows XP Professional
- Minimum computer: 500 MHz Pentium® III (or equivalent); 256 MB memory
Recommended computer: 1 GHz Pentium III (or equivalent); 512 MB memory

Note that, although you use the license key on only one VSX system, you can install the presenter software on an unlimited number of computers.

- Connect the computer(s) to the IP network.

For information about purchasing the People+Content IP option, please contact your Polycom distributor.

To enable People+Content IP on a VSX system:

1. On a computer, open a web browser and go to the Polycom web site at www.polycom.com/support/video.
2. Enter your user login information to enter the web site, or click **New User** to create a new account, if needed.
3. Enter the license number you received when you purchased the People+Content IP option.
4. Enter the serial number of the VSX system onto which you want to install People+Content IP. You will then receive a People+Content IP software activation key.
5. Go to **System > Admin Settings > General Settings > Options** on the VSX system.
6. Enter the People+Content IP software activation key.

To install the People+Content IP application on a computer:

1. On a computer with Windows XP or Windows 2000, open a web browser and go to the Polycom web site at www.polycom.com.
2. Select **Downloads & Documentation** from the Quick Links menu.
3. Under Downloads, select **Video** as the Category, and select the appropriate VSX system under Products.
4. Download and install the People+Content IP software.



For information about showing content using People+Content IP, refer to the *Getting Started Guide for the VSX Series* at www.polycom.com/vidocumentation.

Configuring Closed Captioning

You can provide real-time text transcriptions or language translations of the video conference by displaying closed captions on your system. When you provide captions for a conference, the captioner may be present, or may use a telephone or web browser to listen to the conference audio. When the captioner sends a unit of text, all sites see it on the main monitor for 15 seconds. The text then disappears automatically.

Closed captions are supported between Polycom HDX systems with software version 1.0 or later and VSX systems with software version 7.0 or later.

Captions may be provided in any language that uses the Latin alphabet.

The captioner may enter caption text using one of the following methods:

- Remotely, via a dial-up connection to the system's serial RS-232 port
- In the room using equipment connected directly to the serial port
- In the room or remotely, using the system's web interface
- In the room or remotely, using a Telnet session

Via a Dial-Up Connection to the Systems' RS-232 Serial Port

Closed captioners can provide captions from inside the conference room, or from a remote location, via a dial-up connection to the serial port of the VSX system, as shown in the following diagram.

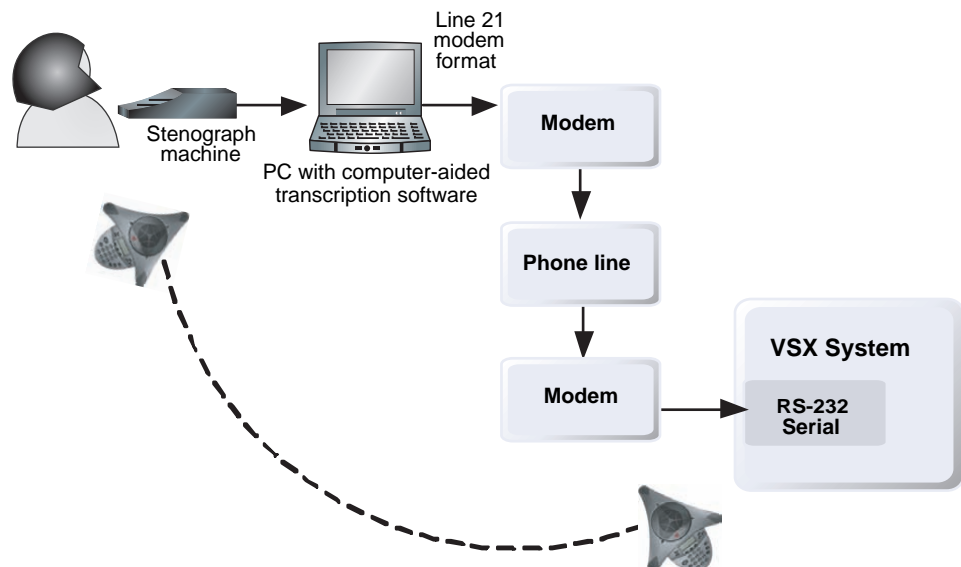

To supply closed captions via a dial-up connection:

1. Ensure that the computer and the VSX system are configured to use the same baud rate and parity settings.
 2. Go to **System > Admin Settings > General Settings > Serial Port** and set the RS-232 Mode to **Closed Caption**.
 3. Establish a dial-up connection between the computer and the VSX system.
 - a. Connect a null modem adapter to the RS-232 serial port.
 - b. Connect an RS-232 cable to the modem and to the null modem adapter.
 - c. Connect the modem to a phone line.
 - d. Configure the modem for 8 bits, no parity.
- You may need to configure the modem to answer automatically. You may also need to configure it to ignore DTR signals.
4. On the computer, start the transcription application.
 5. Enter text using the stenographic machine connected to the computer.
 6. To stop sending closed captions, close the transcription application.

Via the System's Serial RS-232 Port

Closed captioners can provide captions from inside the conference room, using equipment connected directly to the serial port of the VSX system, as shown in the following diagram.

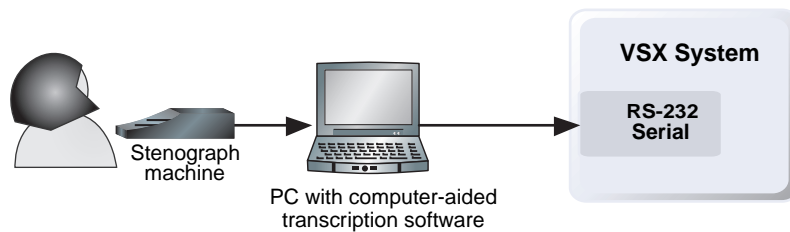

To supply closed captions using equipment connected directly to the serial port:

1. Ensure that the computer and the VSX system are configured to use the same baud rate and parity settings.
2. Go to **System > Admin Settings > General Settings > Serial Port** and set the RS-232 mode to **Closed Caption**.
3. On the computer, start the transcription application.
4. Enter text using the stenographic machine connected to the computer.
5. To stop sending closed captions, close the transcription application.

Via the System's Web Interface

Closed captioners can provide captions from inside the conference room, or from a remote location, by entering the captions directly into the system's web interface, as shown in the following diagram.

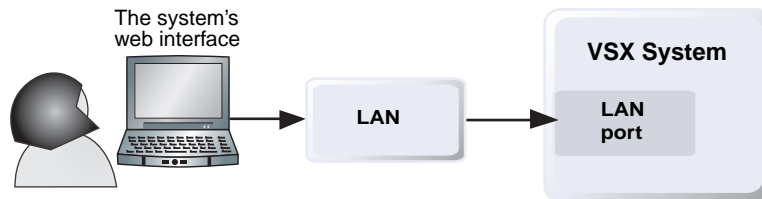

To supply closed captions for a conference using the system's web interface:

1. On a computer, open a web browser.
2. In the browser address line, enter the IP address of the system, for example, `http://10.11.12.13`, to go to the system's web interface.
3. Go to **Utilities > Closed Caption**.
4. Log in using this information:
 - **User Name:** Your name.
 - **Password:** Meeting password defined for your video conferencing system.
5. In the Closed Caption screen, type the caption text into the text field. Text wraps to the next line after 59 characters.
6. Press **Enter** to send the text to the sites in the conference.

Via a Telnet Session

Closed captioners can provide captions from inside the conference room, or from a remote location, by entering captions via a Telnet session, as shown in the following diagram.

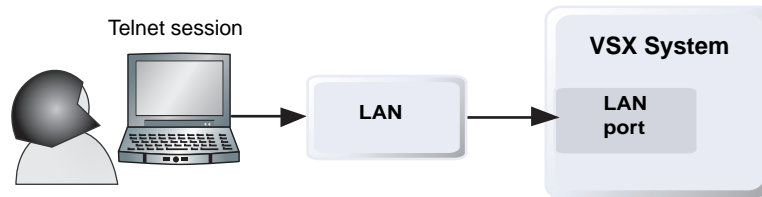

To supply closed captions for a conference via a Telnet session:

1. On a computer, open a command line interface.
2. Start a Telnet session using the VSX system IP address and port 24, for example, `telnet 10.11.12.13 24`.
3. Enter the command `cc` to start captioning.
4. Press **Enter** to send the text.
5. To stop sending closed captions, enter **Ctrl-z**.

Calling and Answering

Configuring Call Settings

The Call Settings screens provide access to high-level options for the entire system. For convenience, some of the User Settings options are repeated on these screens.

To configure call settings:

1. Go to **System > Admin Settings > General Settings > System Settings > Call Settings**.
2. Configure these settings on the Call Settings screen:

Setting	Description
Allow Mixed IP and ISDN Calls VSX 3000 VSX 3000A VSX 7000 VSX 7000s VSX 7000e VSX 8000	Specifies whether users can make multipoint calls that include both IP and H.320 sites. Clearing this option provides extra security for systems requiring LAN connectivity while placing encrypted calls over ISDN lines. If you clear this selection, IP systems cannot join ISDN calls.
Maximum Time in Call	Enter the maximum number of minutes allowed for call length. When that time has expired, you see a message asking you if you want to hang up or stay in the call. If you do not answer within one minute, the call automatically disconnects. If you choose to stay in the call at this time, you will not be prompted again. Choosing 0 removes any limit.

Setting	Description
Auto Answer Point-to-Point Video	Specifies whether to answer incoming point-to-point calls automatically.
Auto Answer Multipoint Video VSX 3000 VSX 3000A VSX 7000 VSX 7000s VSX 7000e VSX 8000	Specifies whether to answer incoming multipoint calls automatically.

3. Select  and configure these settings:

Setting	Description
Display Time in Call	Specifies whether to display the elapsed time or the local time during a call. You can also choose not to display the time.
Call Detail Report	Specifies whether to collect call data for the Call Detail Report and Recent Calls list. When selected, information about calls can be viewed through the system's web interface and downloaded as a .csv file. Note: If this setting is disabled, the Call Detail Report (CDR) will stop recording new entries for any calls placed or received. As a result, applications that retrieve the CDR, such as the CDR synchronization feature of the Polycom Global Management System will no longer reflect new call activity.
Recent Calls	Specifies whether to display the Recent Calls button on the home screen. The Recent Calls screen lists the site number or name, the date and time, and whether the call was incoming or outgoing. Note: If the Call Detail Report option is not selected, the Recent Calls option is not available.
Far Site Name Display Time	Turns the far site name display on or off, or specifies the time period the far site name appears on screen when calls first connect.

Setting the Call Answering Mode

To set the call answering mode:

1. Go to **System > Admin Settings > General Settings > System Settings > Call Settings**.
2. Select **Auto Answer Point-to-Point Video** to set the answer mode for calls with one site, or select **Auto Answer Multipoint Video** (VSX 3000, VSX 3000A, VSX 7000, VSX 7000s, VSX 7000e, and VSX 8000 only) to set the mode for calls with two or more other sites.
3. Select one of the following:
 - **Yes** – Answers calls automatically.
 - **No** – Enables you to answer calls manually.
 - **Do Not Disturb** – Refuses incoming calls automatically. The caller receives a message that the site is unavailable.

If you have a VSX 3000 or VSX 3000A system that you are using as your computer monitor, Polycom recommends that you set up the system so that you have to answer calls manually. If you receive a call while using the system as a computer, you hear a ringing sound and you can switch to video to answer the call manually. Alternatively, you can ignore the call and it will not connect, thereby preventing the caller from seeing or hearing you at your desk.

Configuring Multipoint Calling

You can use your VSX system to participate in multipoint conferences. Multipoint conferences include multiple video sites and can also include voice-only sites. During a multipoint call, a multipoint conferencing unit (MCU) enables the video to switch to the various sites so that you can see and hear the other conference participants.

The VSX 3000, VSX 3000A, VSX 7000, VSX 7000s, VSX 7000e, and VSX 8000 systems can host multipoint calls. These systems can also use the Conference on Demand feature of Polycom's Path Navigator for multipoint calling. The VSX 5000, VSX 6000, and VSX 6000A systems can participate in multipoint calls but cannot host them.

Depending on your VSX system model, you may need to enter a multipoint option key to enable multipoint calling.

Entering a Multipoint Option Key

Before placing multipoint calls, you may need to enter a multipoint option key. A five-minute multipoint trial is available.

For information about purchasing the multipoint call option, please contact your Polycom distributor.

To enter the multipoint option key:

1. Go to **System > Admin Settings > General Settings > Options**.
2. Enter the multipoint option key.

To enable or disable multipoint trial mode:

1. Go to **System > Admin Settings > General Settings > Options**.
2. Select the **Enable Multipoint Trial** checkbox to allow five-minute multipoint calling without the multipoint option key.

Configuring with PathNavigator's Conference on Demand Feature

If your organization uses Polycom's PathNavigator, you can use PathNavigator's Conference on Demand feature to place multipoint calls with up to 10 sites, including the site that places the call.

In order to place calls using PathNavigator, you need to:

- Register your VSX system with PathNavigator
- Configure your VSX system to use PathNavigator for multipoint calls
- Create a multi-site entry in the directory that can be used to place the multipoint call



Points to note about PathNavigator's Conference on Demand:

Once the call begins, users cannot add another site to the call — even if the site was in the call originally and is attempting to rejoin. Because of this, you cannot place cascaded multipoint calls through PathNavigator.

Including More Than Three Other Sites in a Cascaded Call

You can include multiple sites in a cascaded call if the sites you call have the internal MCU capability. The following diagram shows how to do this.

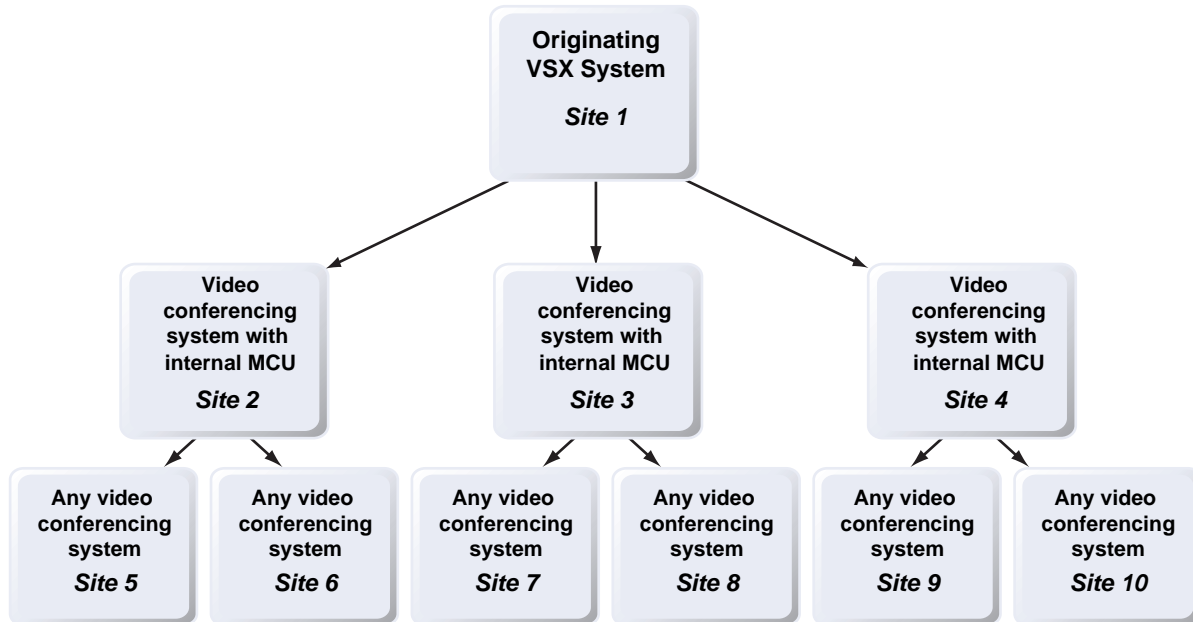

To place a cascaded call:

1. Create and call a multiple-site entry from the directory, or place calls one at a time to up to three other sites.
2. Ask each far site to call up to two additional sites. Along with these additional sites, each far site in the original multipoint call can add one audio-only connection.



Points to note about cascaded calls:

- You cannot place cascaded multipoint calls through PathNavigator.
- Polycom StereoSurround, Pro-Motion, AES encryption, continuous presence, chair control, People+Content, and H.239 are not supported in cascaded calls.
- H.264 is only supported when all of the MCUs are VSX 8000 systems and each VSX 8000 calls no more than three other systems.

Configuring Directory Settings

To configure system settings:

1. Go to **System > Admin Settings > General Settings > System Settings > Directory**.
2. Configure these settings on the Directory screen:

Setting	Description
System Name	Enter or change the system name in this field. This name appears on the screen for the far site when you are making calls.
Localized System Name	Displays the localized system name, if you have entered one. You can enter a Localized System Name for Simplified Chinese on this screen using the Chinese Virtual Keyboard. You must use the system's web interface to enter localized system names for other languages. The localized system name is sent to the far site and displayed as the caller ID by VSX systems running version 8.0 or later, when the user interface is set to that language. However, the English/Pinyin name is the name used by the Global Directory Server and the gatekeeper, and it is also the name that shows up in the Recent Calls list.
Allow Directory Changes	Specifies whether users can save changes they make to the directory.
Confirm Directory Additions Upon Call Disconnect	Specifies whether users are prompted to confirm new directory entries when saving the information for the last site called.
Confirm Directory Deletions	Specifies whether users are prompted to confirm deletions of directory entries.

Creating a Localized System Name with the System's Web Interface

Localized system names are sent to the far site and displayed as the caller ID by VSX systems running version 8.0 or later. When you enter a localized system name, it is also entered in English/Pinyin. The English/Pinyin name is the name used by the Global Directory Server, the gatekeeper, and other systems that do not support this feature, and it is also the name that shows up in the Recent Calls list.

To create a localized system name using the system's web interface:

1. On a computer, open a web browser.
2. In the browser address line, enter the system's IP address, for example, `http://10.11.12.13`, to go to VSX Web.
3. Go to **Admin Settings > General Settings > System Settings**.
4. Enter the localized system name in the appropriate language field.

Managing Directories with the System's Web Interface

The system's web interface import/export directory feature allows you to maintain consistency of VSX system directories in your organization efficiently. It is particularly useful for administrators managing multiple systems that call the same locations. You can:

- Transfer existing directory entries between VSX systems
- Develop directory entries on one system, save them to your computer, and then distribute them to other systems
- Create localized directory entries

Only local directories can be downloaded. The directory file is in .csv format.

To export a VSX system directory to your computer:

1. On a computer, open a web browser.
2. In the browser address line, enter the system's IP address, for example, `http://10.11.12.13`, to go to VSX Web.
3. Go to **Utilities > Import/Export Directory**.
4. Click **VSX → PC** to export the .csv file to the computer.
5. Save the file to a location on your computer.

To import VSX system directory entries to the VSX system:

1. On a computer, open a web browser.
2. In the browser address line, enter the system's IP address, for example, `http://10.11.12.13`, to go to VSX Web.
3. Go to **Utilities > Import/Export Directory**.
4. Click **PC → VSX**.
5. Click **Browse** and browse to the location of the .csv file on your computer.
6. Import the .csv file to the VSX system.

To create a localized directory entry using the system's web interface:

1. On a computer, open a web browser.
2. In the browser address line, enter the system's IP address, for example, `http://10.11.12.13`, to go to VSX Web.
3. Go to **Place a Call > Directory**.

Edit an entry to enter a localized directory entry name in the **Localized Name** field, and specify the language for the localized directory entry.

Configuring the Global Directory

The global directory provides a list of other systems that are registered with the Global Directory Server and available for calls. The other systems appear in the directory, allowing users to place calls to other users by selecting their names.

To configure the Directory Server settings:

1. Go to **System > Admin Settings > Global Services > Directory Servers**.
2. Configure these settings on the Global Directory Servers screen:

Setting	Description
Global Directory (GDS)	Specifies the IP address or DNS address of the Global Directory Server. If you specify a Polycom CMA system here, the system cannot register to other servers. If you specify another Global Directory server, you can enter up to five addresses.
Password	Lets you enter the global directory password, if there is one.
Register	Registers this system with the Global Directory Server.
Display Global Addresses	Displays other registered systems in the global directory.
Display Name in Global Directory	Specifies whether to display the system's name in the Global Directories of other registered systems.

Setting	Description
Save Global Directory to System	<p>Copies the global directory to this local system.</p> <p>When this setting is enabled:</p> <ul style="list-style-type: none"> • Polycom VSX systems with 128 MB that are registered to a Polycom CMA system can display up to 5000 global directory entries. • Polycom VSX systems with 128 MB that are registered to another Global Directory Server can display up to 4000 global directory entries. • Polycom VSX systems with 64 MB can display no more than 1000 global directory entries. <p>When this setting is disabled:</p> <ul style="list-style-type: none"> • Polycom VSX systems can display no more than 1000 global directory entries.
Group Name	<p>Specifies the group name used for global directory entries in the local directory. In the directory, entries from Global Directory Servers are listed in the Polycom GDS group.</p>



The 128 MB systems include Polycom VSX 3000A, Polycom VSX 5000, Polycom VSX 6000A, Polycom VSX 7000s, Polycom VSX 7000e, and Polycom VSX 8000. You can determine the memory size of your system by referring to the System Information page (**System > System Information**); the memory size is noted as (64) or (128) after the Model name.

Setting the Dialing Rules

If your system is connected to your organization’s private network and also to a public network, you may need to specify the codes and prefixes necessary for dialing other systems.

To set the dialing rules:

1. Go to **System > Admin Settings > Global Services > Dialing Rules**.
2. Configure these settings:

Setting	Description
Always Dial Area Code	<p>Specifies that calls to sites in the same area code must include the area code.</p>
Dial 1+ for all USA calls	<p>Specifies that calls to systems in the United States must include a “1” before the area code.</p> <p>Note: Even if you have this setting enabled, you may need to dial 1 and the area code when calling long distance over ISDN within your same area code.</p>

Configuring Streaming Calls

You can configure the VSX system to allow users to stream audio and video from one to many viewers. Viewers watch the conference (people video only) from their computers, as the meeting is taking place. You can start streaming before or during a call.



Points to note about streaming:

- If a password is set on the system, streaming participants must enter it before receiving the stream.
- Participants must have the Apple QuickTime player installed on their computer to view the stream.
- To send a stream across a subnet, multicasting must be enabled on the network or you must unicast to a particular IP address, which will forward the stream to that IP address regardless of the location destination.
- The number of viewers is limited only by your network topology.
- For security reasons, you cannot start streaming from the system's web interface.
- Streaming provides video at a reduced frame rate.
- When the system that is streaming a multipoint call is also hosting the conference, the stream displays the current speaker, no matter how **Multipoint Mode** is configured. When the system that is streaming a multipoint call is not hosting the conference, the stream displays the view from the streaming system.

To configure the VSX system for a streaming call:

1. Go to **System > Admin Settings > Network > IP > Streaming**.
2. Configure these settings:

Setting	Description
Allow Streaming	Specifies whether users can start streaming from the system by making the Start Streaming option available on the Utilities screen.
Enable Streaming Announcement	Specifies whether the names of users logged on to the streaming system are displayed on screen.
Speed	Specifies the speed used for the streaming call.
Number of Router Hops	Specifies the number of routers the data can traverse before it is no longer passed on. For example, when set to 1, the data stays within a subnet.

Setting	Description
Audio Port	Specifies the fixed port used for audio. This can be changed if you need to go through a firewall.
Video Port	Specifies the fixed port used for video. This can be changed if you need to go through a firewall.
IP Multicast Address	Specifies the multicast address used for the stream. The default address is based on your system serial number but can be changed, if required. This could be the unicast location of your streaming server.

To stream a conference:

1. Go to **System > Utilities > Web Streaming**.
2. Select the **Start Streaming** option to begin streaming.
3. Place the video call to other participants.

You can start streaming before or during a call.

To stop streaming a conference:

1. Go to **System > Utilities > Web Streaming**.
2. Clear the **Start Streaming** selection.

To view a streamed conference:

1. On a computer, open a web browser.
2. In the browser address line, enter the system's IP address, for example, `http://10.11.12.13`, to go to the system's web interface.
3. Click **Utilities > View a Meeting**.
4. If prompted, enter the user name and password.

The stream starts automatically.



Participants must have the QuickTime player installed on their system to view the stream.

To stop viewing the streamed conference:

- Close the web browser.

This stops the stream but does not end the call.

System Location, Appearance, and Tones

Setting Date, Time, and Location

You can update the system with regional settings, including the location-specific language and calling parameters.

To set the date, time, and location:

1. Go to **System > Admin Settings > General Settings > Location**.
2. Configure these settings on the Location screen:

Setting	Description
Country	Specifies the country where the system is located. Changing the country automatically adjusts the country code associated with your system number.
Language	Sets the language for the user interface.
Country Code	Specifies the country code for the system location.
Area Code Required	Specifies if an area code is required to place ISDN calls in the specified country.
ISDN International Access	Specifies the international code required for placing ISDN calls from the system location to another country.
Room Telephone Number	Indicates the telephone number of the room where the system is located.

3. Select  and configure these settings:

Setting	Description
Date Format and Time Format	Specifies your format preference for the date and time display and lets you enter your local date and time.
Display Time in Call	Specifies the time display in a call: <ul style="list-style-type: none"> • Elapsed Time – Displays the amount of time in the call. • Local Time – Displays the local time on the screen during a call. • Off – Time is not displayed.

4. Select  and configure these settings:

Setting	Description
Auto Adjust for Daylight Saving Time	Specifies the daylight savings time setting. When you enable this setting, the system clock automatically changes for daylight saving time.
Time Zone	Specifies the time difference between GMT (Greenwich Mean Time) and your location.
Time Server	Specifies connection to a time server for automatic system time settings.

Customizing the Home Screen

Designing the Home Screen

Customize according to users' needs, skill levels, and environments.

Infrequent Users (Kiosk Mode)

Provide a simple workspace so no training is needed:

- Let users make calls to pre-defined numbers with one button click.
- Include instructions on screen.

Include a short list of specific items for users to select

Use the marquee to add instructions

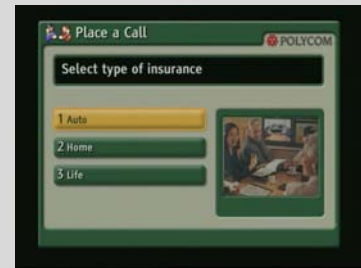

New Users

Provide more options but keep it simple:

- Dialing entry field
- Directory numbers
- Recent Calls

Add features for users as needed



Advanced Users

Provide additional options for advanced video conferencing users:

- Call Quality (bandwidth and call type)
- Multipoint dialing
- User Settings, Diagnostics, and System Information
- Speed Dial list of frequently called sites
- Alerts

Add more features as users gain experience



To design the home screen:

1. Go to **System > Admin Settings > General Settings > Home Screen Settings**.
2. Configure these settings:

Setting	Description
Dialing Display	<p>Specifies which dialing option to display:</p> <ul style="list-style-type: none"> • Dialing entry field — Allows users to enter numbers manually. • Display marquee — Displays text in the dialing entry field. Can be used to display user instructions. Users cannot enter numbers manually when this option is selected. • None — Removes the dialing entry field from the screen.
Contact List	Specifies whether to display the contact list home screen.
Call Quality	Allows users to select the bandwidth for calls, as well as the call type, from the Place a Call screen. For information about enabling call types, see Configuring Call Preferences on page 2-27.
H.323 Extension (E.164)	Allows users to enter extensions on the home screen.
Directory	Allows users to access the directory.
System	Allows users to access the System screen, which includes User Settings, Diagnostics, and System Information. If you remove the System button, you can still access the System screen by navigating to the home screen, pressing  on the remote, and selecting System .
Multipoint VSX 3000 VSX 3000A VSX 7000 VSX 7000s VSX 7000e VSX 8000	Allows users to access the multipoint dialing screen via a Multipoint button on the home screen.

3. Select  and configure these settings:

Setting	Description
System Name	Specifies whether to display the name of the system on the home screen above the PIP window.
IP or ISDN Information VSX 3000 VSX 3000A VSX 5000 VSX 6000A VSX 7000 VSX 7000s VSX 7000e VSX 8000	Specifies whether to display the system's IP address, ISDN number, or both on the home screen.
My Information VSX 6000	Specifies whether to display the system's IP address on the home screen.
Local Date and Time	Specifies whether to display the local date and time on the home screen.
Do Not Disturb Icon	Allows users to set the system to automatically accept or ignore incoming calls using the Do Not Disturb button on the home screen. Users can also access the call forwarding function from this icon.
Call Detail Report	Specifies whether to generate a report of all calls made with the system. When selected, all calls can be viewed through the system's web interface and downloaded as a .csv file. Note: If this setting is disabled, applications such as the Polycom Global Management System will not be able to retrieve Call Detail Report (CDR) records.
Recent Calls	Specifies whether to display the Recent Calls button on the home screen. The Recent Calls screen lists the site number or name, the date and time, and whether the call was incoming or outgoing. Note: If the Call Detail Report option is not selected, the Recent Calls option is not available.



4. Select  and configure these settings:

Setting	Description
Sites	Allows users to access any pre-defined sites from a My Contacts/Speed Dial list on the home screen.
Last Number Dialed	Specifies whether to display the last number dialed or clear the dialing field on the home screen.

Displaying Contacts on the Home Screen

Sites configured for speed dial are displayed on the home screen. You can also display them on the contact list home screen.

To configure speed dial sites:

1. Make sure that the site information is entered in the directory.
2. Go to **System > Admin Settings > General Settings > Home Screen Settings**.
3. Select  two times and enable **Sites**.
4. Select  three times to access the Sites screen.
5. Select **Add** and choose the sites to add from the directory.
6. Select either **Speed Dial** or **Contacts** as the name you want to appear on the button.

To display the contact list home screen:

1. Go to **System > Admin Settings > General > Home Screen Settings**.
2. Select **Contact List**.

Adding Marquee Text

You can create marquee text to display in the dialing entry field on the home screen. You can create context-specific instructions for your users or, if the home screen has Site buttons, the marquee text can provide information that helps users choose which site to call.

To enter marquee text in the system's web interface:

1. Go to **System > Admin Settings > General Settings > Home Screen Settings**.
2. In **Dialing Display**, select **Display marquee** and enter the text.

You can also add marquee text through the system's web interface. For some languages such as Russian, Korean, Japanese, Simplified Chinese, and Traditional Chinese, you must use the system's web interface to add marquee text.

To enter marquee text using the system's web interface:

1. On a computer, open a web browser.
2. In the browser address line, enter the system's IP address, for example, `http://10.11.12.13`, to go to the system's web interface.

3. Enter the user name and remote access password, if a password has been established.
4. Click **Admin Settings > General Settings > Home Screen Settings** and enter.
 - **Dialing Display** – Set to Display marquee.
 - **Enter Marquee Text** – Type the text to display on the home screen.
5. Click **Update**.

Changing System Appearance

Different system appearance options are available, allowing you to coordinate the system interface with the room décor.

To change the system appearance:

1. Go to **System > Admin Settings > General Settings > System Settings > Appearance**.
2. Configure the color scheme.

You can allow users to change color schemes by allowing user access to the User Settings screen.

Applying The Video Overlay

You can apply a video overlay that borders the screen at the near site and that provides information for the user. To customize the video overlay, you can choose the color of the border and can enter text to display. For example, you could apply a yellow video overlay with the text, "Maximum Security," to indicate a system that you have designated as highly secure.



Whether the VSX system is or is not in a call, the video overlay and customized text both appear on the monitor displaying the near-site video, and the customized text alone appears on the screens in the user interface of the near-site system. The far site cannot see the video overlay and customized text on your system.

To apply the video overlay:

1. Go to **System > Admin Settings > General Settings > System Settings > Appearance**.
2. Enter up to 20 English-only characters in the **Overlay Name** field.
3. Configure the color of the video overlay with the **Overlay Theme** setting. The default setting is **None**.



Because the video overlay is displayed on top of the monitor image, portions of video or content might be obscured.

Setting Ring Tones and Alert Tones

To set ring tones and alert tones:

1. Go to **System > Admin Settings > Audio > Audio Settings**.
2. Select a tone, as desired.

To set the VSX 3000 or VSX 3000A system internal ringer:

1. Go to **System > Admin Settings > Audio > Audio Settings**.
2. Select **Enable Internal Ringer** to specify an additional ring tone when receiving an incoming call. The ringer is built into the system and will alert you to incoming calls.

Customizing Camera Names and Icons

Customizing the way cameras appear on screen helps users select the correct camera input during a call. You can enter camera names and assign icons. You can choose camera icons from categories including Corporate, Education, Justice, Manufacturing, and Medical.



To customize camera names and icons:

1. Go to **System > Admin Settings > Cameras**, then select  to go to **Camera Settings**.
2. Enter camera names and select the appropriate icon for each video source.

Screen Savers

Adding Screen Saver Text

You can customize the VSX system to display text when the system is in sleep mode. For instance, you can display on-screen instructions to assist users with what steps they should take next.



Output upon Screen Saver Activation on the Monitors screen must be set to **Black** if you want to display screen saver text.

To enter screen saver text:

1. On a computer, open a web browser.
2. In the browser address line, enter the system's IP address, for example, `http://10.11.12.13`, to go to the system's web interface.
3. Enter the user name and remote access password, if a password has been established.
4. Click **Utilities > Screen Saver** and enter:
 - **Screen Saver Text** – Appears as scrolling text when the system is in sleep mode. You can use this scrolling text to provide instructions or next steps for users of the system.
 - **Logo Screen Text** – Appears underneath the logo before the system goes into sleep mode.
5. Click **Update**.

Adding a Screen Saver News Feed

You can customize the VSX system to display a news feed when the system is in sleep mode.



Output upon Screen Saver Activation on the Monitors screen must be set to **Black** if you want to display a screen saver news feed.

To configure a screen saver news feed:

1. On a computer, open a web browser.
2. In the browser address line, enter the system's IP address, for example, `http://10.11.12.13`, to go to the system's web interface.
3. Enter the user name and remote access password, if a password has been established.

4. Click **Utilities > Screen Saver**, and paste a feed URL into the **News Feed** field.
5. Select a stream content, click **Submit**, and close the stream content window.
6. Click **Update**.

Adding a Screen Saver Logo

You can customize the VSX system to display your own logo instead of the Polycom logo.

To upload a screen saver logo:

1. On a computer, open a web browser.
2. In the browser address line, enter the system's IP address, for example, `http://10.11.12.13`, to go to the system's web interface.
3. Enter the user name and remote access password, if a password has been established.
4. Click **Utilities > Screen Saver**, click **Next**, and follow the onscreen instructions for uploading a logo file.

Changing the Screen Saver Wait Time

To change the screen saver wait time:

1. Go to **System > Admin Settings > General Settings > System Settings > Appearance**.
2. Configure the screen saver wait time to specify how long the system remains awake during periods of inactivity. The default is 3 minutes. Setting this option to **Off** prevents the system from going to sleep.

Security

Screens that Require the Room Password for Access

The following illustration shows which screens require the room password.

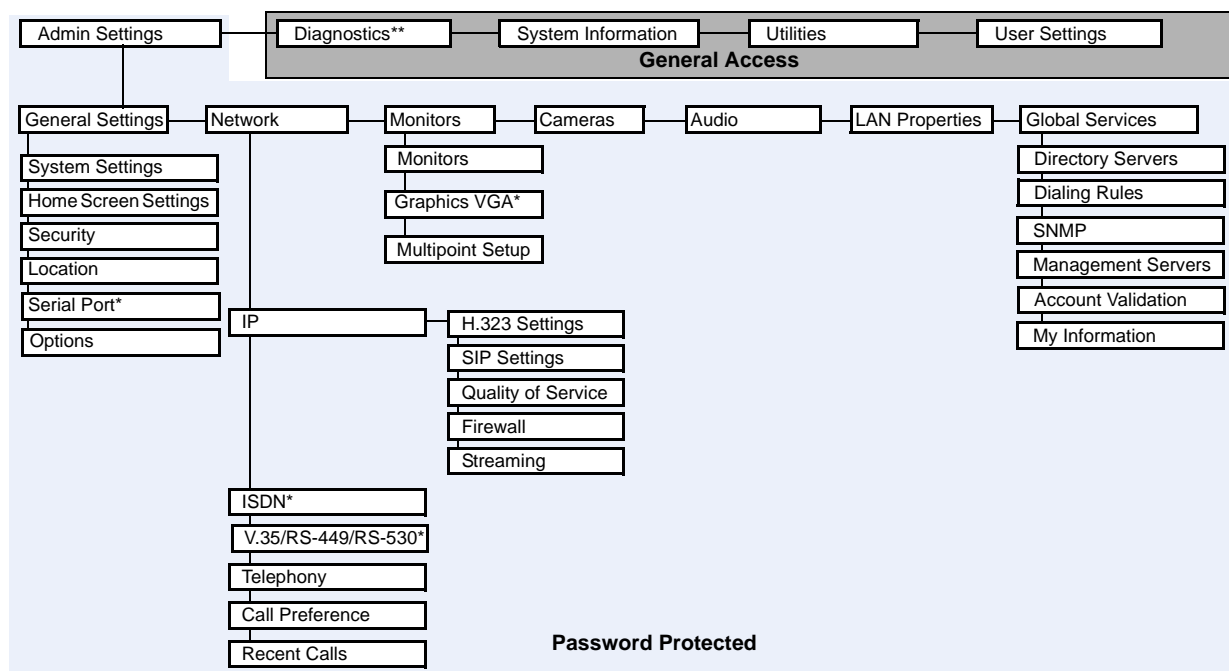

* May not be present for all system types
 **Reset System is password-protected when Security Mode is enabled

Configuring Security Options

To set passwords and security options:

1. Go to **System > Admin Settings > General Settings > Security**.
2. Configure these settings on the Security screen:

Setting	Description
Security Mode VSX 3000A VSX 5000 VSX 6000A VSX 7000s VSX 7000e VSX 8000	Specifies whether the system uses Security Mode, which prevents unsecured access to the system. Every time you enable Security Mode, you must configure a new password for the system.
Use Room Password for Remote Access	Specifies whether the room password and remote access password are the same.
Room Password	Enter or change the room password. When the room password is set, you must enter it to configure the system Admin Settings using the remote control. The room password must not contain spaces.
Meeting Password	Specifies the password users must supply to join multipoint calls on this system if the call uses the internal multipoint option, rather than a bridge. This field can also be used to store a password required by another system that this system calls. If a password is stored in this field, you do not need to enter it at the time of the call; the VSX system supplies it to the system that requires it. The meeting password must not contain spaces.
Remote Access Password	Enter or change the remote access password. When the remote access password is set, you must enter it to upgrade the software or manage the system from a computer. The remote access password must not contain spaces.

3. Select  and configure these settings:

Setting	Description
Enable Remote Access	<p>Specifies whether to allow remote access to the system by:</p> <ul style="list-style-type: none"> • FTP • Web • Telnet • SNMP <p>You may select any of these, or any combination of them.</p> <p>Note: The system restarts if you change the remote access settings. This setting does not deactivate the associated port, only the application. Use Web Access Port to disable the port.</p>
AES Encryption	<p>Specifies how to encrypt calls with other sites that support AES encryption.</p> <ul style="list-style-type: none"> • Off—AES Encryption is disabled. • When Available—AES Encryption is used with any endpoint that supports it, even if the other endpoints in the call don't support it. This setting is available only for 128 MB systems. • Required for Video Calls Only—AES Encryption is used for all video endpoints in the call. Analog phone and voice over ISDN connections are allowed. Video endpoints must support AES Encryption to participate in the call. This setting is available only for 128 MB systems.
Allow Access to User Settings	<p>Specifies whether the User Settings screen is accessible to users via the System screen.</p> <p>Select this option if you want to allow users to change limited environmental settings.</p>
Allow Video Display on Web	<p>Specifies whether to allow viewing of the room where the system is located, or video of calls in which the system participates, using the system's web interface.</p> <p>Note: This feature activates both near site and far site video displays in Web Director.</p>
Web Access Port (http:)	<p>Specifies the port to use when accessing the system using the system's web interface.</p> <p>If you change this from the default (port 80), specify a port number of 1025 or higher, and make sure the port is not already in use. You will need to include the port number with the IP address when you use the system's web interface to access the system. This makes unauthorized access more difficult.</p> <p>Note: The system restarts if you change the web access port.</p>

Setting the Room and Remote Access Passwords

You can set the room password to restrict who can configure system Admin Settings using the remote control. You can set the remote access password to restrict who can upgrade the VSX Series system software or perform other remote management from a computer.

To set or change the room password:

1. Go to **System > Admin Settings > General Settings > Security**.
2. Enter or change the password.

The default room password is the 14-digit system serial number.

To set or change the remote access password:

1. Go to **System > Admin Settings > General Settings > Security**.
2. Clear the **Use Room Password for Remote Access** setting if it is selected. By default, the remote access password is the same as the room password.
3. Enter a **Remote Access** password.

To access Admin Settings using the system's web interface when a remote access password is set, enter "admin" for the user name.

To use the same password for both local and remote access:

1. Go to **System > Admin Settings > General Settings > Security**.
2. Select **Use Room Password for Remote Access**.

To reset a forgotten password:

1. Get the system's serial number from the system or from the System Information screen.
2. Go to **System >Diagnostics > Reset System**.



If Security Mode is enabled, the room password is required to access the Reset System screen. If you forget the room password while the system is in Security Mode, contact your Polycom distributor or Polycom Technical Support.

3. Enter the system's serial number and select **Delete System Settings**.
4. Select **Reset System**.

After the system resets, it leads you through the setup wizard. You can enter a new password when you set up the system.

Managing User Access to Settings and Features

You can manage user access to settings and features by using passwords and by configuring the system to show only those options you want your users to see.

To maintain this security level:	You can allow users to:
High (Kiosk mode)	Call only the numbers you specify on the home screen. See Designing the Home Screen on page 7-3.
Medium	Place calls using the restrictions you specify for length of call, type of call, and use of the directory.
Low	Configure user settings.
Very low	Configure all system settings.

You can allow users to change common user preferences by providing access to the User Settings screen.

To allow users to customize the workspace:

1. Go to **System > Admin Settings > General Settings > Security**.
2. Select the **Allow Access to User Settings** option to make the **User Settings** button available to users on the System screen.

User Settings contains the following options, which are also available to administrators on the Admin Settings screens:

- Backlight Compensation
- Camera Brightness (VSX 3000A)
- Far Control of Near Camera
- Meeting Password
- Auto Answer Point-to-Point or Multipoint Video
- Mute Auto Answer Calls
- PIP
- Keypad Audio Confirmation
- Color Scheme
- Video Overlay
- Far Site Name Display Time
- Dual Monitor Emulation
- Allow Video Display on Web

Configuring Security Mode

You can configure VSX 3000A, VSX 5000, VSX 6000A, VSX 7000s, VSX 7000e, and VSX 8000 systems to use Security Mode, which provides secure access to the system. Security Mode is based on Transport Layer Security (TLS) 1.0 using 168-bit Triple-DES. These protocols encrypt management communication over IP, preventing access by unauthorized users.

Every time you enable Security Mode, you must configure a new password for the system. The password cannot be blank and it cannot be the default value (serial number).

Security Mode requires secure access and a password for Web, Telnet, and FTP access:

- To access a VSX system in Security Mode using the system's web interface, enter the IP address of the system using secure HTTPS access, for example, `https://10.11.12.13`. Click **Yes** in the security dialogs that appear. This access uses port 443. To access Admin Settings using VSX Web when a remote access password is set, enter "admin" for the user name.
- To access a VSX system in Security Mode using Telnet, you must use a Telnet client that supports TLS. This access uses port 992 or 993.
- To access a VSX system in Security Mode using FTP, use FTPS, or FTPS-TLS, to implement a secure session. This access uses port 990.

To configure the system to use Security Mode:

1. Go to **System > Admin Settings > General Settings > Security**.
2. Enable **Security Mode**.

When you change this setting, the VSX system restarts. Every time a VSX system is powered on or restarts in Security Mode, it verifies that the system software is authentic Polycom software.



Points to note about Security Mode:

- SNMP access is not available in Security Mode.
- Global Management System and ReadManager® SE200 are not compatible with VSX systems in Security Mode.
- Software images for version 8.5 and later are digitally signed by Polycom. To install an earlier version of system software, you must disable Security Mode.
- If Security Mode is not enabled, the system first attempts to use a secure protocol (such as HTTPS), but reverts to the non-secure form of the protocol if the management system does not have a secure client.
- If Security Mode is enabled, you must enter the room password to reset the system (**System > Diagnostics > Reset System**).

Password Encryption



The password encryption feature is an enhancement to Security Mode. Because Security Mode is only available on the 128 MB systems (V700, VSX 3000A, VSX 5000, VSX 6000A, VSX 7000s, VSX 7000e, VSX 8000), password encryption is also only available on the 128 MB systems.

Version 9.0 includes enhanced password encryption for meeting, room, and remote access passwords.

When Security Mode is enabled, the VSX system stores all meeting, room, and remote access passwords using the SHA-1 algorithm rather than using clear text.



When a Polycom VSX system with Security Mode enabled was upgraded from a previous software version to Polycom VSX software version 9.0, the room password no longer worked. As a result, the Admin Settings became inaccessible even when the previously used room password was correctly entered on the system. This has been corrected in Polycom VSX software version 9.0.1.

For a Polycom VSX system with password encryption and Security Mode enabled, Polycom recommends that you delete the room password or disable Security Mode before downgrading from software version 9.0 or later to a build prior to version 9.0.

Password Display

Meeting, room, and remote access passwords now always appear as a series of asterisks as you type them into a configuration screen or login box.

To enter numbers in a password field, use the remote control number buttons. To enter letters in a password field, press  **Keyboard** on the remote control.

Re-entering to Confirm Passwords

In some cases, you must now re-enter passwords to confirm them.

- When updating or entering a meeting, room, or remote access password, you are now prompted to re-enter the password to confirm it.
- When enabling Security Mode, you must now enter and confirm a new room password, even if a room password is already in use on the system.
- When enabling or disabling Security Mode, you must now enter and confirm each meeting, room, and remote access password that is set.







You cannot change the `roomsw`, `sw`, `meetingpassword`, `websw`, and `securemode` configuration variables when using uploaded profiles (**Utilities > Profile Center**) through the system's web interface, even if the uploaded profiles contain one or more of these variables. These configuration variables are also excluded from downloaded profiles.

Enabling AES Encryption

AES encryption is a standard feature on all VSX systems. When it is enabled, the system automatically encrypts calls to other systems that have AES encryption enabled.

Whenever AES Encryption is enabled, the system continually displays an icon. The icon behavior is as follows:

A lock icon in the user interface indicates whether the call is encrypted.

- In a multipoint call, the host system displays  if all connections in the call are encrypted.
- In a multipoint call, the host system displays  if one or more connections in the call are not encrypted.
- Far-end systems that are connected with encryption display .
- Far-end systems that are connected without encryption display .

Some connections might be encrypted while others are not. To avoid security risks, Polycom recommends that all participants communicate the state of their encryption icon verbally at the beginning of a call.



Points to note about AES Encryption:

- You cannot enable AES encryption during a call.
- AES Encryption can be configured for Required for Video Calls Only on 128 MB systems only.
- If you enable Security Mode before upgrading the system to version 9.0.6, this setting is automatically set to When Available but can be changed.
- If you enable Security Mode after installing version 9.0.6 the system uses Required for Video Calls Only for AES Encryption.
- AES Encryption is not supported for systems registered to an Avaya H.323 gatekeeper.

To enable AES encryption:

- Go to **System > Admin Settings > General Settings > Security** and set **AES Encryption**.

Managing the System Remotely

You can configure, manage, and monitor the system from a computer using the system's web interface. You can also use the Polycom Global Management System, SNMP, or the API commands.

- The system's web interface requires only a web browser.
- Polycom Global Management System requires the Global Management System application to be installed on your network.
- SNMP requires network management software on your network management station.
- For more information about the API commands, refer to the *Integrator's Reference Manual for the VSX Series*.

Using the System's Web Interface

You can use the system's web interface to perform most of the calling and configuration tasks you can perform on the local system.

Accessing the System's Web Interface

To configure your browser to use the system's web interface:

1. Be sure that you use Microsoft Internet Explorer 6.x or later as your web browser and that you have Java 1.2 or later installed.
2. Configure these settings:
 - Allow cookies: Enabled
 - Force pages to reload on every visit to a page: Enabled

To access the system using the system's web interface:

1. On a computer, open a web browser.
2. In the browser address line, enter the system's IP address, for example, `http://10.11.12.13`, to go to the system's web interface.

If Security Mode is enabled on the system, you must use secure HTTPS access, for example, `https://10.11.12.13`. Click **Yes** in the security dialog boxes that appear.
3. If prompted, enter `admin` as the user name, and enter the remote access password.

You can use the system's web interface to configure all of the system settings except the remote management settings. For security reasons, these settings must be configured on the local system by an administrator.

Monitoring a Room or Call with the System's Web Interface

The monitoring feature within the system's web interface allows administrators of VSX systems to view a call or the room where the system is installed. For security reasons, this feature can only be enabled on the local system by an administrator.

To enable room and call monitoring:

1. Go to **System > Admin Settings > General Settings > Security**.
2. Select  and enable **Allow Video Display on Web** to allow the room or call to be viewed remotely.

To view a room or call:

1. On a computer, open a web browser.
2. In the browser address line, enter the system's IP address, for example, `http://10.11.12.13`, to go to the system's web interface.
3. Go to **Utilities > Web Director**.
4. Perform any of the following tasks:
 - Place or end a call
 - View near and far sites
 - Change camera sources
 - Adjust camera position
 - Zoom cameras
 - Adjust system volume settings
 - Mute and unmute the microphones

You can view near and far sites without opening Web Director by selecting **Tools > Remote Monitoring**.

Managing System Profiles with the System's Web Interface

Administrators managing systems that support multiple applications can change system settings quickly and easily using profiles. You can store a VSX system profile on a computer as a .csv file using the system's web interface. There is no limit to the number of profiles you can save.

The following settings are included in a profile:

- Home screen settings
- User access levels
- Icon selections
- Option keys
- System behaviors

Passwords are not included when you store a profile.



Polycom recommends using profiles only as a way to back up system settings. Attempting to edit a stored profile or upload it to more than one system on the network can result in instability or unexpected problems.

To store a profile:

1. On a computer, open a web browser.
2. In the browser address line, enter the system's IP address, for example, `http://10.11.12.13`, to go to the system's web interface.
3. Go to **Utilities > Profile Center**.
4. Click **VSX → PC** to download the .csv file from the VSX system.
5. Save the file to a location on your computer.

To upload a profile:

1. Reset the VSX system to restore default settings.
2. On a computer, open a web browser.
3. In the browser address line, enter the system's IP address, for example, `http://10.11.12.13`, to go to the system's web interface.
4. Go to **Utilities > Profile Center**.
5. Click **Browse** and browse to the location of the .csv file on your computer.
6. Click **PC → VSX** to upload the .csv file to your system.

Sending a Message

If you are experiencing difficulties with connectivity or audio, you may want to send a message to the system that you are managing.

Only the near site can see the message; it is not broadcast to all the sites in the call.

To send a message via the system's web interface:

1. On a computer, open a web browser.
2. In the browser address line, enter the system's IP address, for example, `http://10.11.12.13`, to go to the system's web interface.
3. If prompted, enter `admin` as the user name, and enter the remote access password.
4. Go to **Diagnostics > Send a Message**.
5. In the Send a Message page, enter a message (up to 100 characters in length), then click **Send Message**.

The message is displayed for 15 seconds on the screen of the system that you are managing.

Configuring Global Services

If your organization uses the Polycom Global Management System, you can configure, manage, and monitor the VSX system using the Global Management System server. The Global Management System is a web-based client/server software tool that allows administrators to manage a network of video conferencing systems.

Viewing the Management Servers List

On networks managed by the Global Management System, several Global Servers may be configured to manage this system remotely. The system also has a primary Global Management System server that performs account validation. You can view information about these servers, but this information can only be changed by the Global Management System Administrator.

To view the management servers list:

- Go to **System > Admin Settings > Global Services > Management Servers**.

Requiring an Account Number for Calls

If your system is set up for use with the Global Management System, the system can prompt the user to enter an account number before placing a call. The account number is added to the Global Management System's Call Detail Record (CDR) and the system's local CDR file (`localcdr.csv`), and this information can be used for call tracking and billing purposes.

If you do not configure the system to validate account numbers, calls are completed and the entered account number is recorded on the CDR. If you configure the system to validate account numbers, calls are completed only when placed using a valid account number. Account numbers are set up in Global Management System by the Global Management System administrator.

For more information about account validation, please contact your Global Management System administrator.

To require an account number for calls:

1. Go to **System > Admin Settings > Global Services > Account Validation**.
2. Specify whether to require an account number for placing calls and whether that number should be validated by the Global Management System server.

Adding Information for the Global Management System Administrator

If your system is managed by the Global Management System, you can configure the VSX system so that users can request help from the Global Management System administrator.

To configure Global Management contact information on the system:

1. Go to **System > Admin Settings > Global Services > My Information**.
2. Enter the contact information for the Global Management System administrator for technical support.



Valid entries for the Contact Number and Contact Fax fields in the user interface include numbers 0—9, the period (.), the asterisk (*), and the number sign (#).

To configure Global Management contact information from the system's web interface:



1. On a computer, open a web browser.
2. In the browser address line, enter the IP address of the system, for example, `http://10.11.12.13`, to go to the system's web interface.
3. If prompted, enter `admin` as the user name, and enter the remote access password.
4. Go to **Admin Settings > Global Services > My Information**.



Valid entries for the Contact Number and Contact Fax fields in the system's web interface include spaces, numbers 0—9, the period (.), the asterisk (*), and the number sign (#).

The following section illustrates the interaction between Global Management System and the system you are configuring.

Requesting Technical Support from the Global Management System Administrator

If you need to contact the Global Management System administrator, press  on the remote control from the home screen, select **Support** and press . The administrator receives an alert to call you at the number you specified on the My Information screen.

Setting Up SNMP

The VSX system sends SNMP (Simple Network Management Protocol) reports to indicate conditions, including the following:

- All alert conditions found on the VSX system alert page
- Details of jitter, latency, and packet loss
- Low battery power is detected in the remote control
- A system powers on
- Administrator logon is successful or unsuccessful
- A call fails for a reason other than a busy line
- A user requests help
- A telephone or video call connects or disconnects

VSX systems are compatible with SNMP version 1 and version 2c (v2c).

Downloading MIBs

In order to allow your SNMP management console application to resolve SNMP traps and display human-readable text descriptions for those traps, you need to install Polycom MIBs (Management Information Base) on the computer you intend to use as your network management station.

The MIBs are available for download from the system's web interface.

To download the Polycom MIBs:

1. On a computer, open a web browser.
2. In the browser address line, enter the IP address of the system, for example, `http://10.11.12.13`, to go to the system's web interface.
3. Go to **Admin Settings > Global Services > SNMP**.
4. Click **Download MIB** and follow the onscreen instructions.

Configuring for SNMP Management

To configure the VSX system for SNMP management:

1. Access the SNMP configuration screen either in the system's web interface or on the VSX system:
 - In the system's web interface, go to **Admin Settings > Global Services > SNMP**.
 - On the VSX system, go to **System > Admin Settings > Global Services > SNMP**.
2. Configure these settings:

Setting	Description
Enable SNMP	Allows administrators to manage the system remotely using SNMP.
Trap Version	Specifies the trap protocol that the system uses. <ul style="list-style-type: none"> • v2c — System uses the v2c trap. • v1 — System uses the v1 trap.
Read-Only Community	Specifies the read-only SNMP management community in which you want to enable this system. This community is also used for traps. The default community is public . Note: Polycom does not support SNMP write operations on the VSX system.
Contact Name	Specifies the name of the person responsible for remote management of this system.

Setting	Description
Location Name	Specifies the location of the system.
System Description	Specifies the type of video conferencing device.
Console IP Address	Specifies the IP address of the computer you intend to use as your network management station and to which SNMP traps will be sent.

Keeping Your Software Current

If you have Internet access and a software key, you can use the web-based Softupdate application to update the VSX Series software. If you do not have Internet access, your reseller can supply you with the VSX system software update on CD-ROM.



Do not power off the system during the software upgrade process. If the upgrade is interrupted, the system may become unusable.

To update your software via the Internet:

1. Using a web browser, go to www.polycom.com/support/video.
2. Navigate to your product software.

Refer to the *Release Notes* for information about the latest software version. Refer to *Upgrading Polycom Video Software* for detailed information about obtaining software key codes and using the Softupdate program.

3. Download the VSX Series software update file in .zip format.
4. Double-click the software .zip file to extract the file.
5. Double-click **Softupdate.exe** to run the update program.



If you install version 8.5 or later on a VSX system that has Security Mode enabled, the system verifies that the software being installed is authentic Polycom software. To install a version earlier than 8.5, you must disable Security Mode on the VSX system.



Control Devices

Configuring Remote Control Behavior

You can customize the behavior of the remote control to support the users' environment.

To configure remote control behavior:

1. Go to **System > Admin Settings > General Settings > System Settings > Remote Control**.
2. Configure these settings:

Setting	Description
Keypad Audio Confirmation	Specifies whether to play a voice confirmation of numbers selected with the remote control.
Remote Control Keypad	Specifies whether pressing remote control keypad buttons moves the camera to presets or generates DTMF tones. If this is set to Presets , users can generate DTMF tones by pressing  on the remote control while on a video screen.
Snap Button Option	Specifies alternative uses for the  Snap button on the remote control. Choose from Mute Speakers , Calendar , Recent Calls , System Info , Call Statistics , or Off .
Chinese Virtual Keyboard	Specifies the type of onscreen keyboard to display for Simplified Chinese. This setting is only available when the system's Language is set to Simplified Chinese.
Use Non-Polycom Remote	Configures the system to accept input from a programmable, non-Polycom remote control. In most cases the Polycom remote works as designed, even when this feature is enabled. However, try disabling this feature if you experience difficulty with the Polycom remote. For more information about VSX system IR codes, refer to the <i>Integrator Reference Manual for the VSX Series</i> .

Connecting Control and Accessibility Equipment

The VSX 5000, VSX 6000, VSX 6000A, VSX 7000, and VSX 7000s systems provide one RS-232 port; the VSX 7000e and VSX 8000 systems provide two. Depending on the type of system you have, you can use the RS-232 serial ports to:

- Connect a modem and use a closed captioning service
- Pass data from a device connected to your system to a device connected to the far site system
- Control the system through a touch-panel using the API
- Provide control signals for an additional camera
- Provide control signals for a Polycom Vortex mixer



You will need to configure the RS-232 equipment according to the manufacturer's instructions, and you will need to configure the RS-232 serial port on the system exactly the same way.

Connecting Touch-Panel Controls

You can connect an AMX or Crestron control panel to the RS-232 serial port of some systems as part of a custom room installation. You will need to program the control panel. Refer to the *Integrator's Reference Manual for the VSX Series* for information about the API commands.

Connecting IR Sensors to VSX 8000 Systems

The VSX 8000 system provides a connector for an external IR sensor. Refer to your system's setup sheet for connection details.

The VSX 8000 system is compatible with the following IR sensors:

- Xantech® 480-00
- Xantech 490-90
- Xantech 780-80
- Xantech 780-90



The VSX 8000 system is not compatible with the external IR sensor for the VS4000™ system.

Configuring RS-232 Serial Port Settings

1. Go to **System > Admin Settings > General Settings > Serial Port**.
2. Configure these settings:

Setting	Description
Baud Rate	Set the baud rate to the same value that it is set on the serial device.
RS-232 Mode	<p>Specifies the mode used for the serial port.</p> <p>Note: Available settings depend on the VSX system model.</p> <ul style="list-style-type: none"> • Control—Receives control signals from a touch-panel control. Allows any device connected to the RS-232 port to control the system using API commands. • Sony PTZ—Provides control signals to a PTZ camera. • Closed Caption—Receives closed captions from a captioning service using a modem, or directly from a captioner's computer via Telnet. • Vortex Mixer—Provides control signals to a Polycom Vortex mixer. • Pass Thru—Passes data to an RS-232 device connected to the serial port of the far-site system. • Polycom Annotation—Provides control signals to the Instructor™ RP. • Debug—Provides a Telnet trace for debugging. You can only set one RS-232 port at a time to Debug mode.

Statistics and Diagnostics

The VSX system provides various screens that allow you to review information about calls made by the system and to review network usage and performance.

Diagnostics Screens

The following Diagnostics screens are available on the system and in the web interface.

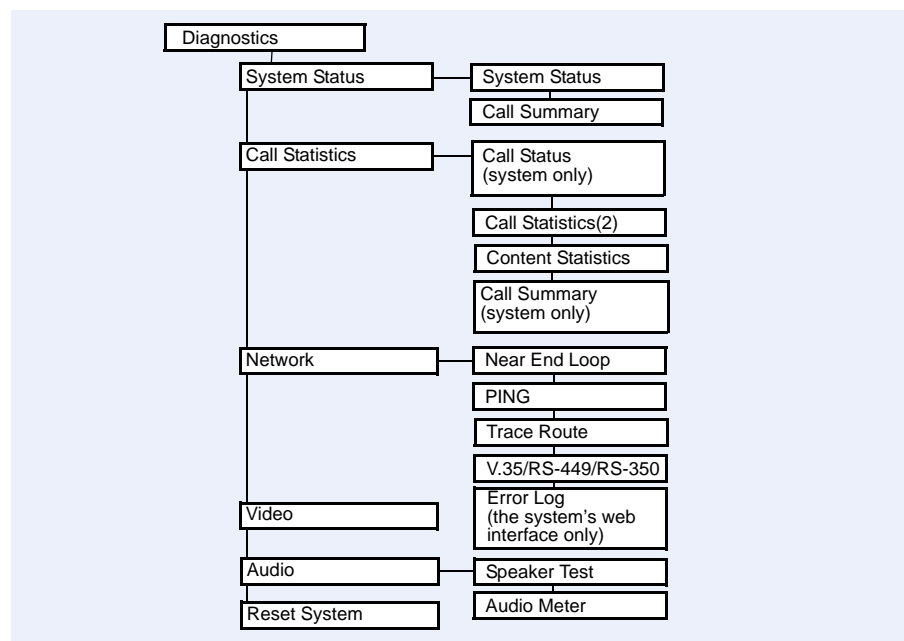

To access the Diagnostics screens on the system:

- Go to **System > Diagnostics**.

To access the Diagnostics screens from the system's web interface:

1. On a computer, open a web browser.
2. In the browser address line, enter the system's IP address, for example, `http://10.11.12.13`, to go to the system's web interface.
3. If prompted, enter `admin` as the user name, and enter the remote access password.
4. Click **Diagnostics** from any page in the system's web interface.

System Status

Diagnostic Screen	Description
System Status	Displays system status information, including auto-answer point to point, remote control battery, time server, global directory, IP network, gatekeeper, and ISDN BRI line. For an explanation of any of the status items, select the item and press  on the remote. When there is a change in system status that is a potential problem, you see an alert at the bottom of the Place a Call screen.

Call Statistics

Diagnostic Screen	Description
Call Status (system only)	<p>Displays call type, data speed, and number dialed for the current call. You can highlight the spheres on this screen to see the number dialed, the relevant status code, and details of any errors.</p> <p>In ISDN calls, this screen also displays connection status for each channel. Selecting a channel call progress indicator displays its ISDN number.</p>
Call Statistics	<p>Displays call speed, audio and video protocols, annexes, and error count for the call in progress.</p> <p>View Call Statistics during a call by pressing  Help on the remote control.</p> <p>Call Statistics (1)</p> <ul style="list-style-type: none"> • Call speed (transmit and receive) • Video protocol, annexes, and format in use (transmit and receive; the video protocol is shown in green if the system is currently using error concealment) • Audio protocol in use (transmit and receive) • Number of packets lost and percentage packet loss (transmit and receive) in IP calls • Encryption type, key exchange algorithm type, and key exchange check code (if the encryption option is enabled and the call is encrypted) • Far site details and call type <p>Call Statistics (2)</p> <ul style="list-style-type: none"> • Audio and video data rates specified (transmit and receive) • Video data rate and frame rate in use (transmit and receive) • Video packet loss and jitter in IP calls • Audio packet loss and jitter in IP calls • Far site details and call type <p>Content Statistics</p> <p>The Content Statistics screen shows statistics for content shared during a call, including transmit statistics for People+Content IP.</p>
Call Summary	<p>The Call Summary screen provides details about the calls placed by the system, including:</p> <ul style="list-style-type: none"> • Duration of the last call • Total number of calls placed and received • Number, total time, and percentage of IP calls • Number, total time, and percentage of ISDN calls

Network

Diagnostic Screen	Description
Near End Loop	<p>Tests the system's audio and video circuitry, camera and monitor.</p> <p>The monitor displays the video and plays the audio that would be sent to the far site in a call.</p> <p>This test is not available when you are in a call.</p>
PING	<p>Tests whether the system can establish contact with a far-site IP address that you specify.</p> <p>If the test is successful, the VSX system displays a message indicating that the IP address under test is available.</p>
Trace Route	<p>Tests the routing path between the local system and the IP address entered.</p> <p>If the test is successful, the VSX system lists the hops between the system and the IP address you entered.</p>

Video

Diagnostic Screen	Description
Video Diagnostics	<p>Tests the color settings of your monitor for optimum picture quality.</p> <p>If the color bars generated during the test are not clear, or the colors do not look correct, the monitor needs to be adjusted.</p>

Audio

Diagnostic Screen	Description
Speaker Test	<p>Tests the audio cable connections. A 473 Hz audio tone indicates that the local audio connections are correct.</p> <p>If you run the test from the system during a call, the far site will also hear the tone.</p> <p>If you run the test from the system's web interface during a call, the people at the site you are testing will hear the tone, but you will not.</p>
Audio Meter	<p>Measures the strength of audio signals from the system's microphone.</p> <ul style="list-style-type: none"> To check the microphone, speak into the microphone. To check far-site audio, ask a participant at the far site to speak or call a phone in the far-site room to hear it ring. <p>The audio meter should register between 0 and 15 dB.</p>

Restart System

Diagnostic Screen	Description
Restart System	<p>Cycles power to the system.</p> <p>When you reset the system using the remote control, the system's user interface allows you to:</p> <ul style="list-style-type: none"> Keep your system settings (such as system name and network configuration) or restore factory settings. Keep or delete the directory stored on the system. <p>You may wish to download the CDR and CDR archive before you reset the system. See Call Detail Report (CDR) on page 11-6.</p>

Recent Calls

When the **Call Detail Report** setting is enabled, Recent Calls shows a list of up to 99 calls made by the system. It includes the following information:

- Site name or number
- Date and time
- Call in or out

The Recent Calls list shows incoming and outgoing calls that connect, as well as outgoing calls that do not connect.

If Do Not Disturb has been enabled, any incoming calls attempted by other sites will not be listed.

The home screen can be configured to include Recent Calls. For more information about including the Recent Calls list on the home screen, see [Designing the Home Screen](#) on page 7-3.

To view the Recent Calls screen:

- Go to **System > Admin Settings > Network > Recent Calls**.

You can see more detail about any call by highlighting an entry and pressing  **Help** on the remote. Information includes the far site's number and name, and the type, speed (bandwidth), and duration of the call.

If you need even more detail about calls, you can download the Call Detail Report (CDR) from the system's web interface. For more information about the CDR, see [Call Detail Report \(CDR\)](#).

Call Detail Report (CDR)

When enabled, the Call Detail Report (CDR) provides the system's call history. You can view the CDR from the system's web interface, and you can download the data in CSV format for sorting and formatting. CSV (Comma Separated Value) files can be imported into spreadsheet and database programs.

Every call that connects is added to the CDR, whether it is a call that you make or that you receive. If a call does not connect, the report shows the reason. In multipoint calls, each far site is shown as a separate call, but all have the same conference number.

The CDR does not include incoming calls that the VSX system does not answer, so if calls were missed while Do Not Disturb was enabled, details will not be included in the CDR.

To view and download the CDR via the system's web interface:

1. On a PC, open a web browser.
2. In the browser address line, enter the system's IP address, for example, `http://10.11.12.13`, to go to the system's web interface.
3. Enter `admin` as the user name, and the remote access password, if a password has been established.
4. Click **Utilities > Call Detail Report** to view the details of the file.
5. Click **Save** and then specify a location on your computer to save the file.



As an added security feature, downloading the CDR file with the format `xxx.xxx.xxx.xxx/localcdr.csv` requires a username and password in VSX system software version 8.5.2 and later.

Information in the CDR

The following table describes the data fields in the CDR.

Data	Description
Row ID	Each call is logged on the first available row. A call is a connection to a single site, so there may be more than one call in a conference.
Start Date	The call start date, in the format dd-mm-yyyy.
Start Time	The call start time, in the 24-hour format hh:mm:ss.
End Date	The call end date.
End Time	The call end time.
Call Duration	The length of the call.
Account Number	If Require Account Number to Dial is enabled on the system, the value entered by the user is displayed in this field.
Remote System Name	The far site's system name.
Call Field Number 1	The number dialed from the first call field, not necessarily the transport address. For incoming calls — The caller ID information from the first number received from a far site.
Call Field Number 2 (If applicable for call)	For outgoing calls — The number dialed from the second call field, not necessarily the transport address. For incoming calls — The caller ID information from the second number received from a far site.

Data	Description
Transport Type	The type of call — Either H.320 (ISDN) or H.323 (IP).
Call Rate	The bandwidth negotiated with the far site.
System Manufacturer	The name of the system manufacturer, model, and software version, if they can be determined.
Call Direction	In — For calls received. Out — For calls placed from the system.
Conference ID	A number given to each conference. A conference can include more than one far site, so there may be more than one row with the same conference ID.
Call ID	Identifies individual calls within the same conference.
Total H.320 Channels Used	The total number of ISDN B channels used in the call. For example, a 384K call would use six B channels.
Endpoint Alias	The alias of the far site.
Endpoint Additional Alias	An additional alias of the far site.
Endpoint Type	Terminal, gateway, or MCU.
Endpoint Transport Address	The actual address of the far site (not necessarily the address dialed).
Audio Protocol (Tx)	The audio protocol transmitted to the far site, such as G.728 or G.722.1.
Audio Protocol (Rx)	The audio protocol received from the far site, such as G.728 or G.722.
Video Protocol (Tx)	The video protocol transmitted to the far site, such as H.263 or H.264.
Video Protocol (Rx)	The video protocol received from the far site, such as H.261 or H.263.
Video Format (Tx)	The video format transmitted to the far site, such as CIF or SIF.
Video Format (Rx)	The video format received from the far site, such as CIF or SIF.
Disconnect Reason	The description of the Q.850 (ISDN) cause code showing how the call ended.
Q.850 Cause Code	The Q.850 cause code showing how the call ended.
Total H.320 Errors	The number of errors during an H.320 call.

Data	Description
Average Percent of Packet Loss (Tx)	The combined average of the percentage of both audio and video packets transmitted that were lost during the 5 seconds preceding the moment at which a sample was taken. This value does not report a cumulative average for the entire H.323 call. However, it does report an average of the sampled values.
Average Percent of Packet Loss (Rx)	The combined average of the percentage of both audio and video packets received that were lost during the 5 seconds preceding the moment at which a sample was taken. This value does not report a cumulative average for the entire H.323 call. However, it does report an average of the sampled values.
Average Packets Lost (Tx)	The number of packets transmitted that were lost during an H.323 call.
Average Packets Lost (Rx)	The number of packets from the far site that were lost during an H.323 call.
Average Latency (Tx)	The average latency of packets transmitted during an H.323 call based on round-trip delay, calculated from sample tests done once per minute.
Average Latency (Rx)	The average latency of packets received during an H.323 call based on round-trip delay, calculated from sample tests done once per minute.
Maximum Latency (Tx)	The maximum latency for packets transmitted during an H.323 call based on round-trip delay, calculated from sample tests done once per minute.
Maximum Latency (Rx)	The maximum latency for packets received during an H.323 call based on round-trip delay, calculated from sample tests done once per minute.
Average Jitter (Tx)	The average jitter of packets transmitted during an H.323 call, calculated from sample tests done once per minute.
Average Jitter (Rx)	The average jitter of packets received during an H.323 call, calculated from sample tests done once per minute.
Maximum Jitter (Tx)	The maximum jitter of packets transmitted during an H.323 call, calculated from sample tests done once per minute.
Maximum Jitter (Rx)	The maximum jitter of packets received during an H.323 call, calculated from sample tests done once per minute.

Call Detail Report Archives

Calls are added to the CDR until the file size reaches 50 KB, which is equivalent to about 150 calls. The system then automatically archives the CDR and creates a new CDR file. If an archive is already present, the new archive overwrites it.

The CDR starts with Row 1, but the conference numbers continue from the file most recently archived. Conference numbering restarts at 1 after the system assigns conference number 100,000.

To get an archived CDR:

1. From your computer, open an FTP client.
2. FTP into the VSX system.
3. Enter this FTP command:



```
GET localcdr_archive.csv
```
4. Close your FTP session.

Troubleshooting

Placing a Test Call

When you finish configuring the system, you can use one of the sample numbers in the directory to test your setup.

To place a test call:

1. On the **Place a Call** screen, select  **Directory**.
2. Select **Group**.
3. Select **Sample Sites** and highlight a location.
4. Press  **Call** on the remote control.

You can also find a list of worldwide numbers that you can use to test your VSX system at www.polycom.com/videtest.

If you have trouble making video calls:

- Make sure the number you dialed is correct, then try the call again. For example, you may need to dial 9 for an outside line or include a long distance access code or country code.
- To find out if the problem exists in your system, ask the person you were trying to reach to call you instead.
- Find out if the system you are calling has its power turned on and is functioning properly.
- If you can make calls but not receive them, make sure that your system is configured with the correct number.

Enabling Basic Mode

Basic Mode is a limited operating mode that uses H.261 for video and G.711 for audio. It provides administrators with a workaround for interoperability issues that cannot be solved using other methods. The Basic Mode setting stays in effect until you change it. The Call Statistics screen indicates whether the system is operating in Basic Mode.



Basic Mode disables many system features such as content sharing, far-site camera control, and advanced audio and video algorithms. Use Basic Mode only when calling systems that fail to operate properly with these advanced features.

To enable Basic Mode using the system's web interface:

1. On a computer, open a web browser.
2. In the browser address line, enter the system's IP address, for example, `http://10.11.12.13`, to go to the system's web interface.
3. Go to **Admin Settings > Network > Call Preference**.
4. Select **Enable Basic Mode**.

To enable Basic Mode in the system's user interface:

1. Go to **System > Admin Settings > Network > Call Preferences**.
2. Select **Basic Mode**.

To view the Basic Mode indicator:

1. Go to **System > Diagnostics > Call Statistics**.
2. Select .
3. View the Call Type field.

“(Basic Mode)” is appended to the data in the Call Type field when the VSX system or V Series system is operating in Basic Mode.

General Troubleshooting

This section presents problems, likely causes, and corrective actions. It is organized by category to help you troubleshoot any issue.

- [Power and Start-up](#)
- [Controls](#)
- [Access to Screens and Systems](#)

- [Calling](#)
- [Displays](#)
- [Cameras](#)
- [Audio](#)
- [Error Indications](#)

Power and Start-up

Symptom	Problem	Corrective action
The system does not start or respond in any way.	The power switch is off. Note: VSX 3000 and VSX 3000A systems have three power switches.	Turn on the power switches for the system and all equipment connected to it.
	The power cord is not connected.	VSX 3000, VSX 3000A, VSX 5000, VSX 6000, VSX 6000A: Make sure the power pack is connected to a power outlet, and that its power cords are seated securely. VSX 7000, VSX 7000s: Make sure that the system is connected to the subwoofer and that the subwoofer is connected to a power outlet. The power for the system is supplied by the subwoofer, so it must be connected in order for the system to work. VSX 7000e, VSX 8000: Make sure that the system's power cord is in place, and that it is connected to a power outlet.
	The power outlet is not active, or the system's power supply is not operating properly.	If you connect the system's power cord to a power strip, be sure the power strip is connected to a power outlet and its power switch is on. Check the power outlet by unplugging the system and plugging in a lamp, radio, or other small appliance. If it does not operate, the outlet is not active — connect the system to a different outlet. If the outlet is active, the problem could be in the system's power supply. In this case, call Polycom Technical Support and arrange to return the system for service.

Symptom	Problem	Corrective action
The system starts in the software update screen.	The power switch was pressed for too long. (VSX 7000e, VSX 8000) This is normal.	To power up the system, press and release the power button.
	The system software is corrupted or not loaded properly.	Load the system software from your computer. For instructions on how to do this, refer to Keeping Your Software Current on page 9-8.
The system restarts over and over again.	The power plug is not fully seated.	Make sure the power plug is seated securely.
	The socket is corroded.	Unplug and reseat the power plug 5 times.
	The power plug is damaged or the power supply is bad.	Call Polycom Technical Support and arrange to return the system for service.
The system does not power off when you press the power switch. (VSX 7000e, VSX 8000)	The power switch was not pressed for long enough. This is normal.	Press and hold the power switch for one second to power off. The indicator light changes to blue when the system is powered off.
The system does not power off when you press and hold the power switch. (VSX 7000e, VSX 8000)	The power switch is bad.	Call service for an RMA to return the defective part.
The system locks up upon restart.	You assigned a static IP address of xxx.xxx.xxx.255 (for example, 172.26.145.255).	<ol style="list-style-type: none"> 1. Disconnect the network cable, power off the system, and restart the system. The system now has a static IP address of 0.0.0.0. 2. Configure the system to obtain a different static IP address via DHCP. 3. Reconnect the network cable, and restart the system.

Controls

Symptom	Problem	Corrective action
The system does not respond to the remote control.	No, low, or dead batteries in the remote control.	Install three AAA batteries in the remote control.
	The batteries are installed incorrectly in the remote control.	Insert the batteries in the correct +/- position.
	The room lights operate in the 38 KHz range and interfere with the remote control signals.	Turn off the lights in the room and try the remote control again.
	The infrared sensor is not receiving signals from the remote control.	To check the remote control: Point the remote control directly at the camera and press a button. If the light on the system flashes, the remote control works properly. Make sure the transparent protective strip has been removed from the infrared sensor on the front of the system. Make sure you are pointing the remote control at the infrared sensor on the front of the system or the camera.
	VSX 8000: The external infrared sensor is not operating properly.	Check the connections between the rear panel, cable adapter, and infrared sensor cable.
The monitor screen remains blank when you pick up the remote control.	The monitor's power cord is not plugged in.	Connect the monitor's power cord and then power on the monitor.
	The monitor is powered off.	Power on the monitor.
	The monitor is not connected correctly to the system.	Verify that the monitor is connected correctly according to the manufacturer's instructions and the setup sheet you received with the system.
	The monitor is not set to use the signal input that is connected to the VSX system.	On the monitor, change the signal input. The image may take a few seconds to synchronize after you select the signal input that is connected to the VSX system.
The remote control does not work in voice-only calls using the SoundStation VTX 1000 conference phone.	This is normal.	Use the SoundStation VTX 1000 conference phone controls in voice-only calls.

Symptom	Problem	Corrective action
The system does not respond to the touch-panel control.	The RS-232 serial port is not configured as a touch-panel input.	Go to Admin Settings > General Settings > Serial Port and verify the following: <ul style="list-style-type: none"> • Baud Rate is set to the same value on the system as on the touch-panel. • RS-232 Mode is set to Control. • VSX 7000e, VSX 8000: The touch-panel is connected to the port that is configured as a touch-panel port.
A change in the Directory is not saved.	If you edit an entry and then press Home on the remote, you are prompted to save your change, but the change is not saved.	Choose Save first before you press Home .
The remote control in the system's web interface is disabled.	The system is in Security Mode.	This is normal.

Access to Screens and Systems

Symptom	Problem	Corrective action
Cannot navigate to Admin screens — System button is not displayed.	The home screen is not configured to display the System button.	Press the  button on the remote and select System at the end of the help message, or access the system remotely using the system's web interface, FTP, Telnet, or SNMP. From the system's web interface, you can add the System button back to the home screen. Click System Setup and navigate to Admin Settings > General Settings > Home Screen Settings , then select System . The change takes effect after you navigate away from the home screen and then back again on the system.
Cannot navigate to Admin screens without a password.	The system administrator has set a password, or The default password was not deleted.	Enter the password. The default password is the system's serial number.

Symptom	Problem	Corrective action
Cannot access the system remotely.	The system does not allow remote access.	On the system, go to Admin Settings > General Settings > Security >  and enable access.
	The system or your computer is not connected to the LAN.	Check the LAN cable to the LAN port on the rear of the system. Check the LAN cable to your computer.
	The LAN cable to the system or to your computer is bad. To verify this, check the lights on the system. There should be a steady green light indicating a connection to the LAN, and a flashing orange light indicating LAN traffic if the cable is good.	Replace the appropriate LAN cable.
	DHCP Client is ON and no DHCP server is available.	Contact your network administrator.
	There is a firewall between your computer and your system.	Contact your network administrator.
	Your computer is on a different network and there is not connectivity between the networks.	Place your computer and system on the same subnet. If this corrects the problem, check your router configuration. If it does not, contact your network service provider.
	The system requires that you provide new passwords when switching into Security Mode.	Enter a new password when prompted by the system.
	The system is in Security Mode, which requires secure access.	Use secure modes of Telnet, FTP, Web, and serial access. For more information, refer to Configuring Security Mode on page 8-6.
Cannot manage the system remotely.	You have not entered the correct password.	Enter the correct user name and remote access password. Note: For web access, the user name is admin , and the default password is the unit's serial number.
	Too many managers are logged into the system.	Only five system managers are allowed at any one time. To log everyone out, restart your system.
Cannot connect to the Directory Server.	The system does not automatically reconnect to the Directory Server when a network cable is unplugged and reconnected.	Recheck Register on the Global Directory Servers screen (System > Admin Settings > Global Services > Directory Servers) to manually reconnect to the Directory Server.

Calling

Symptom	Problem	Corrective action
Error message occurs when placing an IP (H.323) call.	The system is not connected to the LAN.	Verify that the LAN cable is connected properly.
	The system's LAN cable is bad.	Replace the system's LAN cable.
	The far site is not connected.	Use the PING test (System > Diagnostics > Network > PING) to determine whether the far site is accessible to your system. If the test fails, the far site system is unavailable.
	The system is not configured correctly for the network.	Check your IP configuration.
	The IP Gateway/Gatekeeper is not operating or is not configured correctly.	Contact the gatekeeper/gateway administrator.
	Calls do not connect.	Use the PING test (System > Diagnostics > Network > PING) to determine whether the far site is an H.323 device. If it is not an H.323 device and you are sure the IP address is correct, it is likely that address is not on your network. This is especially true with addresses beginning with 10., 168.254, 172.16 through 172.31, or 192.168, which are private networking addresses.
	If you are unable to place calls to known sites on your network, a gatekeeper might be blocking calls from unregistered systems.	Register with the gatekeeper.
System displays a message indicating network congestion when placing an ISDN call immediately after starting the system.	This can occur if the system uses a PRI E1 network interface module that is connected to an Adtran Atlas 800 Plus module. After power on, the Adtran module must complete channel restarts before the system can complete ISDN calls.	Wait about three minutes and try the call again.
The call is dialed as voice over ISDN when using the Recent Calls list to recall an analog or cell phone from a previous POTS call.	VSX 8000: ISDN Voice is listed ahead of Analog Phone in the Call Preference dialing order.	Set Analog Phone ahead of ISDN Voice in the Call Preference list.

Symptom	Problem	Corrective action
ISDN: Line Status icons do not go away so video calls cannot be made.	The system is not connected to an ISDN line.	Check the ISDN line connections.
	The ISDN number is entered incorrectly.	Check the ISDN numbers with your service provider.
	The ISDN line is provisioned incorrectly by the ISDN service provider.	Check that your ISDN line is provisioned for Voice/Data.
	The VSX system is in an unknown state.	Power off the system, wait five seconds, and power on the system.
	The Quad BRI network interface is directly connected to a user interface.	Install an NT-1 device between your network interface module and the ISDN connection.
	The Quad BRI network interface is connected to an NT-1 then to a PBX S/T interface.	You do not need an NT-1 device when connecting to a PBX S/T interface. Connect the system directly to the PBX S/T connection.
	The system was not able to auto-detect SPIDs, or the SPID numbers are entered incorrectly. Note: The AT&T point-to-point protocol does not require SPIDs.	Select the Clear icon on the Auto Detect SPIDs page, and then select the Start icon to automatically detect the new SPIDs. Make sure your ISDN numbers are entered correctly. Check with your ISDN service provider and enter the SPIDs and switch protocol manually. Note: The AT&T point-to-point protocol does not require SPIDs.
ISDN: When placing a call, progress indicators do not turn green.	The call does not connect properly.	Try the call again.
	The NT-1 device is not powered on.	Verify power on the NT-1 device.
ISDN: Calls cannot be completed successfully. The green light on the NT-1 device flashes slowly.	There is a problem with the VSX system or between it and the NT-1 device.	Check for other problems listed in this table.
ISDN: Calls cannot be completed successfully. The green light on the NT-1 device flashes rapidly.	There is a problem on the network side of the NT-1 device.	Contact your ISDN service provider.
ISDN: Calls cannot be completed successfully when using the Recent Calls list.	Some ISDN switches add the area code to numbers when calling from the Recent Calls list.	Set the system to dial local numbers without an area code.

Symptom	Problem	Corrective action
Limited call rate in a multipoint video call with at least one audio-only IP system.	The call rate is limited to 64 kbps if the audio-only IP system is called first.	Call all video systems before calling audio-only IP systems.
Error message occurs when placing an ISDN (H.320) call.	An ISDN cause code is received from the ISDN line.	Try the call again. For more information, please refer to Q.850 Cause Codes on page D-4 .
	The highest-numbered channel did not connect. The system cannot make a call if this channel does not connect.	Be sure you are calling the correct number. The number may need to include: <ul style="list-style-type: none"> • A digit for an outside line • A long distance access code • An international access code • A country code • An area code or city code Check that all network cables are properly connected. Power off the system, wait five seconds, and power on the system. Then wait about two minutes to allow the ISDN lines to resynchronize. Ask the person at the far site to call your system.
	The ISDN switch type is not configured correctly on the VSX system.	Check the ISDN configuration and verify with your ISDN service provider that the system is configured correctly.
	The network interface module is not connected properly.	Check the cables to the network interface module.
The PBX does not accept calls of type "unknown" from the PRI network interface module.	The PRI network interface is not configured correctly.	Verify that you have configured the system's PRI network interface correctly. For detailed instructions, see Configuring the PRI Network Interface on page 2-21 .
ISDN Calls do not connect at the requested data rate.	Not all the ISDN B channels connect.	Set the number of lines to be dialed to a lower number. For more information on specifying the number of lines, refer to Configuring the BRI Network Interface on page 2-19 .
A system using a V.35/RS-449/RS-530 interface cannot receive calls at certain speeds.	V.35/RS-449/RS-530 systems cannot determine how to allocate bandwidth for call speeds that are divisible by both 56 and 64 (such as 448K: 8 x 56K), so the call cannot be connected correctly.	Call the far site, or have the caller try again at a different call speed.

Symptom	Problem	Corrective action
Cannot complete calls to sites that do not use encryption.	The system displays a message stating that encryption is required.	Your system is configured to require all calls to be encrypted, and encryption is not available at the far site.
Cannot complete Conference on Demand calls to ISDN systems when dialed from an H.323-only system.	The ISDN system numbers provided are not complete.	Provide the full international numbers, including country code, for ISDN systems.
Cannot dial remote system in BONDING 384 K calls. (The call progress circles only show blue or yellow.)	Switch protocol issue.	Start by calling the far site at 1x56, 1x64, 2x56, or 2x64 K, as appropriate. This will verify the primary number. If these calls complete, try 256 K, then 384 K. Being able to dial non-bonded but unable to dial bonded to all locations is usually a switch protocol issue. Verify your ISDN provisioning with the telephone service provider.
Dialing a remote site in calls above some particular speed does not work. (The call progress circles do not turn green, or remain blue after the first channel connects.)	The far site may be unable to accept calls above this speed.	Go to the Call Status screen. Highlight each of the circles for each of the channels dialed. The number dialed for each channel will be displayed as you highlight the corresponding circle. Make sure that the far site has entered the number for each of its ISDN lines correctly. The numbers for Line 1 - Line 4 should correspond to connections 1 - 4 on the Quad BRI network interface module. Lower the number of lines to dial in parallel.
Cannot select the desired speeds for BONDING calls from the speed selection.	Speeds do not show when selecting the speed icon.	<ol style="list-style-type: none"> Go to Admin Settings > Network > Call Preference and select  four times to go to the Call Speeds screen. Select the desired call speeds.
Multipoint calls downspeed when a voice-only call is added.	This is normal.	No action is necessary.
Voice-only calls cannot be placed using a set-top VSX system.	This is normal.	Place voice-only calls using the SoundStation VTX 1000 conference phone.
Voice-only calls cannot be placed using a VSX 7000e or VSX 8000 system.	The system might not have a good connection to a phone line.	Use a telephone to verify that there is a dial tone on the line connected to the input on the VSX system.
Hanging up the SoundStation VTX 1000 conference phone does not end the video call.	This is normal.	Use the SoundStation VTX 1000 conference phone END VIDEO soft key or the VSX system remote control to end video calls.

Symptom	Problem	Corrective action
In a multipoint call hosted by a VSX 7000e, cannot disconnect only one site.	Returning to the Home screen and pressing the Hang Up button on the remote control causes all sites to disconnect from the call.	Display the Near or Far screen, and then press Hang Up . You can then choose which sites to disconnect.
Call streaming to the Web does not work.	You may be attempting to stream to a different subnet and the router is not set to allow multicasting.	Make sure the network is configured to allow multicast streaming. To send a stream across a subnet, enable multicasting on the network or unicast to a particular IP address, which will forward the stream to that IP address regardless of the location destination. You can also test this feature by directing the stream to a specific computer that uses Apple QuickTime as a streaming player.

Displays

Symptom	Problem	Corrective action
Screen is blank; start music plays and Polycom logo appears briefly.	The system is starting. This is normal.	No action required.
Monitor goes blank after displaying the splash screen.	The system goes to "sleep" after a period of inactivity.	The system is sleeping. The system wakes up on any action from the remote control or on an incoming call.
Picture is blank on the main monitor.	The system is sleeping. This is normal.	Pick up the remote control to wake up the system.
The monitor screen remains blank when you pick up the remote control.	The monitor's power cord is not plugged in.	Connect the monitor's power cord and then power on the monitor.
	The monitor is powered off.	Power on the monitor.
	The monitor is not connected correctly to the system.	Verify that the monitor is connected correctly according to the manufacturer's instructions and the setup sheet you received with the system.
The call connects but you cannot see or hear people at the far site although they can see and hear you.	The system is configured for use with a NAT but is not behind a NAT.	Go to Admin Settings > Network > IP > Firewall and ensure that NAT Configuration is Off .
	The system is set for dual monitors with the far site on monitor 2, but it is not actually equipped for this configuration.	Make sure that the monitors and configuration match.

Symptom	Problem	Corrective action
When using two monitors, the second monitor or projector is blank.	VSX set-top and component systems: Only one monitor is enabled.	Enable the system for two monitors on the Admin Settings > Monitors > Monitors screen.
When using two monitors, the same picture is seen on the first and second monitor.	The second monitor is connected to the VCR video output.	Connect Monitor 2 to the Monitor 2 connection on the rear panel of the system.
	You are the only participant in a call placed through an external MCU.	MCUs generally loop the first participant back to itself. Wait for others to join the conference.
	The system is performing a Near End Loop test.	Press  Select on the remote to end the test.
The people at the far site cannot see you.	VSX 3000, VSX 3000A, VSX 5000: The privacy shutter is closed.	Open the privacy shutter.
	You have selected a camera that is not connected.	Select the main camera.
Video is in black and white.	The monitor is connected using the composite monitor connector, but it is configured as S-Video.	Go to Admin Settings > Monitors > Monitors and change the setting to Composite.
	The monitor cable is not connected properly.	Verify that the monitor is connected correctly according to the manufacturer's instructions and the setup sheet you received with the system.
	The monitor cable is bad.	Replace the cable.
VCR/DVD records in black and white.	VCR video format setting (S-Video or Composite) does not match the VCR connection.	Go to Admin Settings > Monitors > Monitors and change the VCR setting. If you use the composite video adapter (RCA to mini-DIN), set VCR to Composite .
The people at your site show up in silhouette in the PIP.	The camera is pointing toward a source of bright light, such as a window.	If it is practical to do so, have the call participants sit in a location where there is no light source behind them. Otherwise, go to Admin Settings > Cameras and select Backlight Compensation .
Video from your site is too dark or too light in the PIP.	Lighting at your site has changed within the past few minutes. During calls, the camera adjusts for the lighting at five-minute intervals.	Pan the camera. It adjusts for the lighting whenever it is moved.

Symptom	Problem	Corrective action
The system does not receive closed captions correctly.	The modem is not connected correctly, or is not configured correctly.	Verify that the modem is connected correctly according to the manufacturer's instructions and the setup sheet you received with the system. Go to Admin Settings > General Settings > Serial Port and verify that RS-232 Mode is set to Closed Caption . Verify that the modem is configured for 8 bits, no parity.
Graphics are displayed on Monitor 1 at all sites even if Monitor 2 has been specified for content.	At least one site does not have dual-stream, People+Content, or H.239 capability. This can occur in calls to older systems that do not support this feature.	ViewStation® owners can upgrade to the latest version of software.
	MCUs, which support this feature, must have the conference configured for this feature.	Configure the MCU for this feature.
No content can be sent in an H.331 call.	The systems are configured with H.264 video and with People+Content turned off.	The site sending content should enable People+Content.
	The V.35 system has People+Content turned off and/or H.239 disabled.	Check that H.239 and People+Content are enabled.
People+Content IP will not run.	The Windows firewall is enabled and is preventing People+Content IP from running.	Disable the Microsoft firewall when using People+Content IP.
Video clips running in Windows Media Player cannot be sent over People+Content IP.	Windows Media Player is configured to use overlays.	Configure Windows Media Player so that it does not use overlays. In Windows Media Player, select Tools > Options > Performance > Advanced . Uncheck "Use overlays".
Edges of picture are cut off when viewing graphics.	Graphics from the far site are displayed on an NTSC monitor.	Use a VGA monitor to display graphics.
	The laptop's display resolution or refresh rate does not match the settings for the Visual Concert VSX.	Be sure the laptop's refresh rate is set to 60 Hz, and that the laptop and the Visual Concert VSX use the same display resolution.

Symptom	Problem	Corrective action
Cannot display content on the main monitor.	The system was changed from using a PAL/NTSC main monitor and a VGA secondary monitor to using a single PAL/NTSC monitor and no second monitor.	Set content for VGA Out and then set content for Monitor 1 .
Call participants cannot see or hear what is being played on the VCR or DVD.	The VCR or DVD is not selected.	Select the VCR (Camera 3): Press  Camera , then press 3.
	The VCR or DVD is not set up correctly.	Check that the VCR or DVD is connected according to the instructions in the section Connecting VCR/DVD on page 5-1. Refer to the manufacturer's instructions to set up the VCR or DVD correctly.
Picture freezes frequently or becomes blocky during an IP call.	There is too much traffic on the LAN. Check the error count on the Call Statistics screen.	Go to Admin Settings > Network > IP > Quality of Service and enable dynamic bandwidth.
	The network is experiencing packet loss.	Go to Admin Settings > Network > IP > Quality of Service and specify a smaller value for Maximum Transmission Unit Size.
Picture freezes frequently during an ISDN call.	Too many network line transmission errors. Check the error count on the Diagnostics > Call Statistics screen to verify this.	Try the call again.
	Network interface cable or cables may be bad.	Replace the cable or cables.
Picture is slow or jerky.	The system is receiving video that includes a large amount of motion.	A background with less motion provides a better, smoother video picture.
	Too many network line transmission errors. Check the error count on the Diagnostics > Call Statistics screen to verify this.	Try the call again, possibly at a lower network speed.
	Only one 64 kbps channel is connecting in your call.	Check the ISDN number of the far site. Ask the far site to call your site.
The video image appears to be tilted.	VSX 5000: The camera is not pointed correctly.	Check that the camera is pointed perpendicular to the subject.

Symptom	Problem	Corrective action
The system is not using Pro-Motion video.	The call speed is lower than the minimum speed you have configured for Pro-Motion video.	Try the call again at a higher speed, or Go to System > Admin Settings > Cameras > > > Video Quality. Change the Pro-Motion Video setting to the desired minimum call speed.
	The video quality for the camera in use is set for Sharpness. This setting is for images with no motion.	Go to System > Admin Settings > Cameras > > > Video Quality. Change the Camera setting to Motion.
	VSX 3000 and VSX 3000A systems send Pro-Motion video for VCR/DVD input only. VSX 5000, VSX 6000, and VSX 6000A systems can receive Pro-Motion video but cannot transmit it.	This is normal.
Video and audio are not synchronized.	The video quality for the camera in use is set for Sharpness. This setting is for images with no motion.	Go to System > Admin Settings > Cameras > > > Video Quality. Change the Camera setting to Motion.
No picture in the PIP window.	VSX 3000, VSX 3000A, VSX 5000: The privacy shutter is closed.	Open the privacy shutter.
Picture freezes on all far-site systems in a multipoint chair control call.	The system that is the broadcaster was disconnected.	Select one of the remaining systems as the broadcaster.
Blue screen in the PIP window.	The VCR input is selected and the VCR is not running. Most VCRs generate a blue screen when the tape is not playing.	Select a different camera or play a tape on the VCR.
	The camera selection is incorrect.	Select the appropriate camera: Press  Camera on the remote, then press the number of the camera you wish to use.
	No video input.	Check that there is a video source connected to the selected input.
	Main camera not working and VSX system displays camera alert.	Restart the VSX system.

Symptom	Problem	Corrective action
PIP goes out of focus when there is no motion for several minutes.	The camera is pointing at an area with no contrasting features. To focus properly, the camera must be able to detect an edge.	Point the camera to an area with limited objects, at different distances, which are moving.
Video artifacts occur in scenes with high motion.	VSX 8000: VSX systems improperly activate Pro-Motion H.264 in calls between a PAL and an NTSC VSX 8000. Pro-Motion should only be used in calls between systems that use the same camera format (both PAL or both NTSC).	Disable Pro-Motion in calls between a PAL VSX 8000 and an NTSC VSX 8000.

Cameras

Symptom	Problem	Corrective action
Camera does not pan or tilt.	You are attempting to move a camera that does not have pan/tilt/zoom capabilities.	Make sure you have selected a pan/tilt/zoom camera.
	Camera control cable is not connected properly.	Check that the camera is connected according to the manufacturer's instructions and the setup sheet you received with the system.
	The RS-232 port is not configured for camera control.	Go to Admin Settings > General Settings > Serial Port and verify that RS-232 Mode is set to Sony PTZ .
	The remote control is not working.	Check that the remote control is functioning according to the instructions in the section Controls on page 12-5.
Separate camera does not work.	The camera is not connected correctly or its power pack is not plugged in.	Check that the camera is connected according to the manufacturer's instructions and the setup sheet you received with the system.

Symptom	Problem	Corrective action
<p>The camera does not track to the person who is speaking.</p> <p>Automatic camera tracking is available only on a VSX 7000e or VSX 8000 system with a Polycom PowerCam Plus camera.</p>	<p>Stereo is enabled in the user interface. This is possible even when you have not set up the system to use stereo.</p> <p>Camera tracking and stereo cannot be used together.</p>	<p>Clear the Enable Polycom StereoSurround selection on the Admin Settings > Audio > Audio Settings screen.</p> <p>Use the remote control to move the camera.</p>
	<p>Participants at the far site have been controlling your camera.</p>	<p>Camera tracking is turned off when the near or far site moves your camera.</p> <p>Press  Auto on the remote control to restore tracking.</p>
	<p>More than one person at the near site is speaking, or the near site is noisy.</p>	<p>Reduce the noise in the room.</p>
	<p>The person who is speaking is moving around the room.</p>	<p>Ask participants to remain in one place when speaking.</p>
	<p>The camera is tracking to presets that are at similar angles — for example, a view of the whole room and a close-up view of a seat in the center of the room.</p>	<p>Clear the presets. When setting new presets, do not set them at similar pan angles.</p>
	<p>The room setup interferes with voice tracking. Large windows, uncarpeted floors, and the way the unit is mounted on a wall or alcove can interfere with voice tracking.</p>	<p>Consider room treatments that provide acoustic damping, such as carpeting and curtains.</p> <p>Ensure that the camera has at least 3 ft (1 m) clearance above, behind, and to each side.</p> <p>Verify that the room is small enough for automatic camera tracking to work properly. Polycom recommends that you use this feature only if the room is 20 x 25 x 9 feet (6.1 x 7.6 x 2.7 m) or smaller.</p>
<p>One site cannot control the other site's camera.</p>	<p>Far-site camera control is not enabled.</p>	<p>Go to System > Admin Settings > Cameras > Camera Settings and enable Far Control of Near Camera.</p>
	<p>One of the systems does not have the far-site camera control capability.</p>	<p>Ask the participants at the far site to aim the camera.</p>

Audio

Symptom	Problem	Corrective action
No audio at your site.	The far site is muted.	Look for the far site Mute icon. Ask the far site to unmute the microphone. Note: The far site's microphone may be muted even if you do not see a far site Mute icon.
	The volume may be turned all the way down on the monitor or external audio system.	Turn up the volume on the appropriate device. Use the remote control to turn up the volume. Check the monitor's or external audio system's volume setting. Then check the system's audio output using the Speaker Test under Diagnostics > Audio . You should hear a 473 Hz tone.
	VSX 6000, VSX 6000A, VSX 7000, VSX 7000s: The midrange speaker and subwoofer may be turned off. This happens if stereo is enabled and is possible even if you have not set up the system to use stereo.	Go to System > Admin Settings > Audio Settings and select  twice. Make sure that Midrange Speaker and Subwoofer Speaker are both On.
	The far site's microphones are not placed correctly.	Ensure that each person who speaks is facing a microphone and is close enough to it.
	The far site's microphone is not connected or does not have power.	Ask the far site to check the cable to the microphone.
	Too many line errors.	Try the call again later.
	ISDN voice algorithm is incorrect.	Go to System > Admin Settings > Network > ISDN . Change the ISDN Voice Algorithm selection (aLaw or uLaw).
	A single monitor VGA configuration does not have an external audio system.	Check the system's audio connections to the external audio system.
	The monitor's audio inputs are not connected properly.	Check audio output using the Speaker Test screen under Diagnostics > Audio . You should hear a 473 Hz tone. Ask someone at the far site to speak into the microphone, and check the Far Site Audio meter on the Audio Meter screen under Diagnostics > Audio to determine whether your system is receiving audio.
The system's audio outputs are not connected properly.	Check the system's audio connections to the monitor, or to the external audio system if one is connected. Verify that the system is connected to the correct audio connectors on the monitor.	





Symptom	Problem	Corrective action
The people at the far site cannot hear you.	The people at your site are too far from the microphone.	Move closer to the microphone.
	Your system's microphone is muted.	Check your system for one or more of these mute indications: <ul style="list-style-type: none"> Near site mute icon on the screen VSX 3000, VSX 3000A: System indicator is red VSX systems using Polycom microphones: Microphone mute light is on To unmute the system, press the  Mute button on the remote control.
	Your system's microphone is not enabled.	Go to System > Admin Settings > Audio > Audio Settings . Select Enable Polycom Microphones if it is not selected.
	No power to near site microphone.	Mute the microphone. If the light remains off, there is no power to the microphone. Check that the conference link cable is properly seated. Replace the conference link cable if the people at the far site still cannot hear you.
	Your system's microphone is not connected, or is connected incorrectly.	Check to be sure the microphone is installed correctly. Check the Polycom Mic or Line Input meter on the Audio Meter screen under Diagnostics > Audio to determine whether your system is sending audio.
	Your system's microphone is connected using the wrong cable.	Refer to Connecting Polycom Microphones to Set-Top or Component Systems on page 4-1 for details on supported hardware configurations.
	Your system's microphone does not work.	Call Polycom Technical Support and arrange to return the system for service.
Not enough volume during a call.	The people at the far site are too far from the microphone.	Ask the people at the far site to move closer to the microphone.
	The volume is set too low on the system.	Turn up the volume using the remote control.
	The volume is set too low on the monitor.	Turn up the volume on your monitor or external audio system.
Sound effects such as the incoming call ring are too loud or too soft.	The sound effects volume is not set at desired level.	Adjust the sound effects volume on the Audio Settings screen. If you do not want to hear sound effects, set the volume to 0.

Symptom	Problem	Corrective action
You hear the incoming call ring when you have set sound effects volume to 0.	VSX 3000, VSX 3000A: The internal ringer is enabled.	On the Audio Settings screen, clear the Enable Internal Ringer option.
Audio sounds raspy in ISDN calls.	ISDN voice algorithm is incorrect.	Go to System > Admin Settings > Network > ISDN . Change the ISDN Voice Algorithm selection (aLaw or uLaw).
You can hear yourself on your system.	The far site microphone is too close to the system's audio speaker. (Far-site systems with separate microphones only)	At the far site, make sure the microphone is placed away from the system's audio speaker.
	The far site audio volume may be too loud.	Turn down the audio volume at the far site.
	The monitor or external audio system is connected to the VCR audio output.	Verify that all equipment is connected correctly according to the manufacturer's instructions and the setup sheet you received with the system.
There is audio feedback when a VCR is connected.	A single VCR is connected so that it can play or record, no tape is present, and VCR - Far and Near Audio or VCR Audio Out Always On is selected.	Place a tape in the VCR.
Startup music plays through the built-in speaker but not through the monitor speakers.	The audio system or monitor speakers are not properly connected.	Check audio connections and volume level on your monitor.
	The monitor's volume is turned all the way down.	Turn up the volume on the monitor.
When music is played during the call, it sounds distorted at the other sites.	The music source is not connected to the system. The system's echo cancellation and noise suppression features may interfere with music that the microphone picks up.	Connect the music source to the system's audio input.
	The network is experiencing packet loss.	Turn off the music. Retry the call.

Symptom	Problem	Corrective action
Audio is not in stereo.	Microphones at the sending site are not placed correctly.	Be sure the microphones are set up as described in Connecting Polycom Microphones to Set-Top or Component Systems on page 4-1. Microphones must be at least 3 ft. (0.9 m) apart and properly positioned. Move the microphones farther apart for clearer stereo imaging. Small changes in distance can have large effects on sound reproduction.
	Speakers at the receiving site are not placed correctly.	Ensure the speakers are about 60° apart as seen from the middle of the seating area.
	Speakers at the receiving site are not connected correctly.	Test both speakers using the test on Diagnostics > Audio > Speaker Test . If you do not hear the 473 Hz tone from both speakers, check the speaker wires and other external audio connections.
	The receiving site is not set up for stereo sound.	Advise the people at the receiving site that the sound will be in stereo only if the system is set up for stereo as described in Placing Speakers to Play Stereo from Far Sites on page 4-7 and Connecting Polycom Microphones to Set-Top or Component Systems on page 4-1. Check whether stereo is enabled on the Admin Settings > Audio Settings screen.
	Echo cancellation is enabled on the balanced audio input. This disables the stereo feature.	If you are not using the audio mixer, clear the Echo Canceller selection on the second Admin Settings > Audio Settings screen.
	The call speed is too low. The system only sends stereo audio in calls placed at 256 kbps and higher.	Try the call at a higher speed.
	The system is configured for single monitor VGA.	Stereo audio is disabled by default on all systems that support VGA as the main (or single) monitor.
	The system is in a cascaded call.	Stereo audio is disabled when the system is in a cascaded call.
	Encryption is selected.	Stereo audio is disabled when encryption is selected.
Dual monitor emulation is selected.	Stereo audio is disabled when dual monitor emulation is selected.	

Symptom	Problem	Corrective action
Stereo audio comes from the wrong speaker.	VSX 7000, VSX 7000s, VSX 7000e, VSX 8000: Microphones are incorrectly identified in the system.	Swap the microphones on the Admin Settings > Audio Settings screen.
	Speakers are connected incorrectly.	Connect the speaker on the left to the system's white audio output connector, and the speaker on the right to the red audio output connector.
Video and audio are not synchronized.	The video quality for the camera in use is set for Sharpness. This setting is for images with no motion.	Go to System > Admin Settings > Cameras > > ▶ > Video Quality . Change the Camera setting to Motion.
The SoundStation VTX 1000 conference phone controls do not adjust volume in video calls.	This is normal.	Use the VSX system remote control to adjust the system in video calls.
The Audio Meter screen shows a reading for Polycom Mic but no microphone is connected - the system receives local audio from a mixer.	Echo cancellation is in use. The system displays the audio line input level in this case.	This is normal.

Error Indications

Symptom	Problem	Corrective action
The System Information screen shows "waiting" in the IP Video Number field.	The LAN is not working.	Check the LAN connection. Contact your network administrator.
	The DHCP server is not available.	Contact your network administrator to correct the problem with the server or to assign a static IP address.
The home screen shows "0.0.0.0" as the system's IP address.	The LAN cable is not connected.	Check the LAN cable connection to the LAN port on the system.
	The system was configured for a static IP address of 0.0.0.0.	Go to System > Admin Settings > LAN Properties and correct the IP address settings.
	The system is configured for DHCP, and no DHCP server is available or responding on the network.	Contact your network administrator to correct the problem with the server or to assign a static IP address.
	The system is partially or incorrectly configured for firewall/NAT operation.	Go to System > Admin Settings > Network > IP > Firewall >  and verify the NAT (WAN) Public Address setting.
The system displays a message indicating network congestion when placing an ISDN call immediately after starting the system.	This can occur if the system uses a PRI E1 network interface module that is connected to an Adtran Atlas 800 Plus module. After power on, the Adtran module must complete channel restarts before the system can complete ISDN calls.	Wait about three minutes and try the call again.
The system displays a message stating that there are too many global directory entries.	The system's global directory display is limited to 4000 entries.	<ol style="list-style-type: none"> Go to System Information >  >  >  System Status, highlight Global Directories, and press the  Help button. The system lists the Global Directory servers to which it is registered, and the number of directory entries from each. Unregister the system from one or more of the Global Directory servers.
Low battery icon on the screen.	Low batteries in the remote control.	Replace the batteries in the remote control with 3 AAA batteries.

Symptom	Problem	Corrective action
The system displays a message stating that the security certificate for the web site "Polycom" cannot be verified.	The system is in Security Mode.	Click "Yes, I want to accept the certificate" to continue normal operation.
When using the system's web interface, the web browser's pop-up blocker prevents you from receiving the dialog box used to update the password and enter Security Mode.	The web browser pop-up blocker is enabled.	Disable your pop-up blocker before starting the password change, or temporarily bypass it by holding down the CTRL key while pressing OK to the "Any changes made to this setting will cause your system to restart" message.

How to Contact Technical Support

If you are not able to make test calls successfully and you have verified that the equipment is installed and set up correctly, contact your Polycom distributor or Polycom Technical Support.

To contact Polycom Technical Support, go to www.polycom.com/support.

Enter the following information, then ask a question or describe the problem. This information helps us to respond faster to your issue:

- The 14-digit serial number from the System Information screen, the bottom of the system, or the back of the system
- The software version (from the home screen, select **System > System Information**)
- Information about your network
- Troubleshooting steps you have already tried

System Back Panel Views

VSX 3000 and VSX 3000A Connector Panel

The connectors face downward on the VSX 3000 and VSX 3000A systems. This is a view from underneath the system.

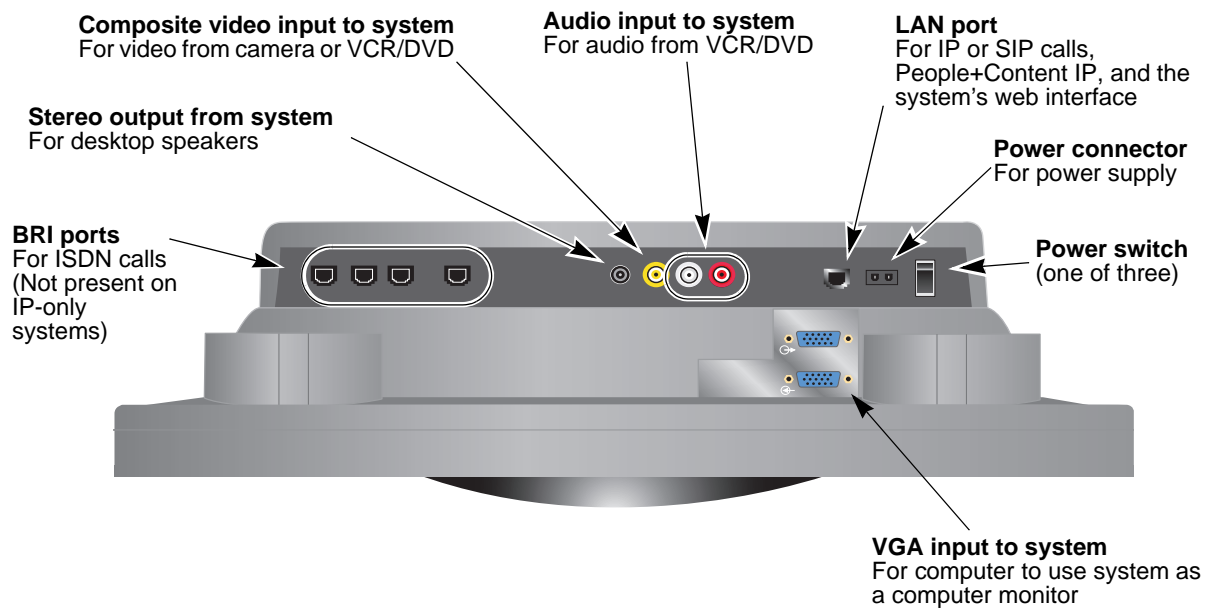

VSX 5000 Back Panel

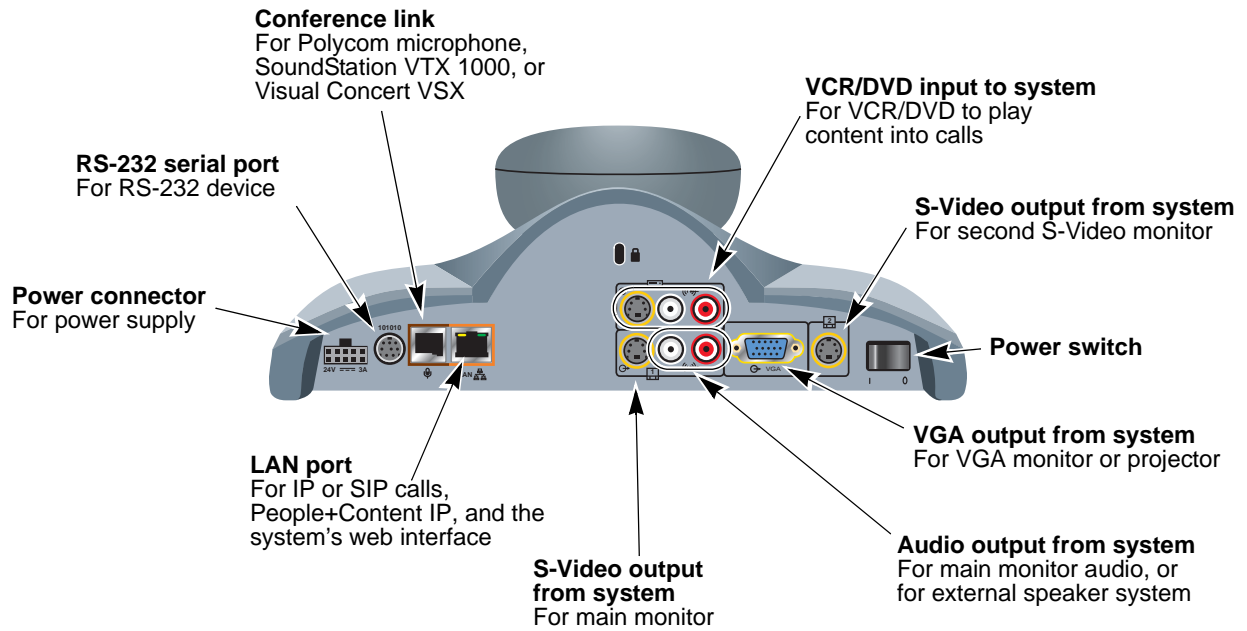

VSX 6000 Back Panel

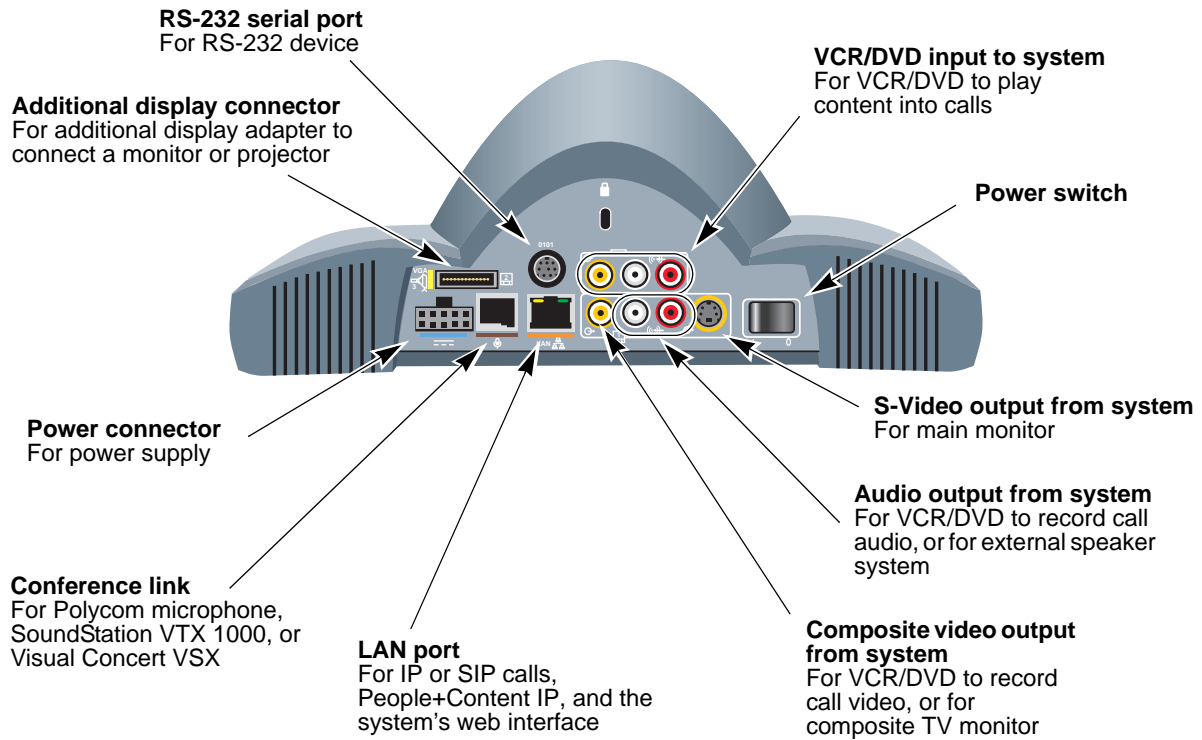

VSX 6000A Back Panel

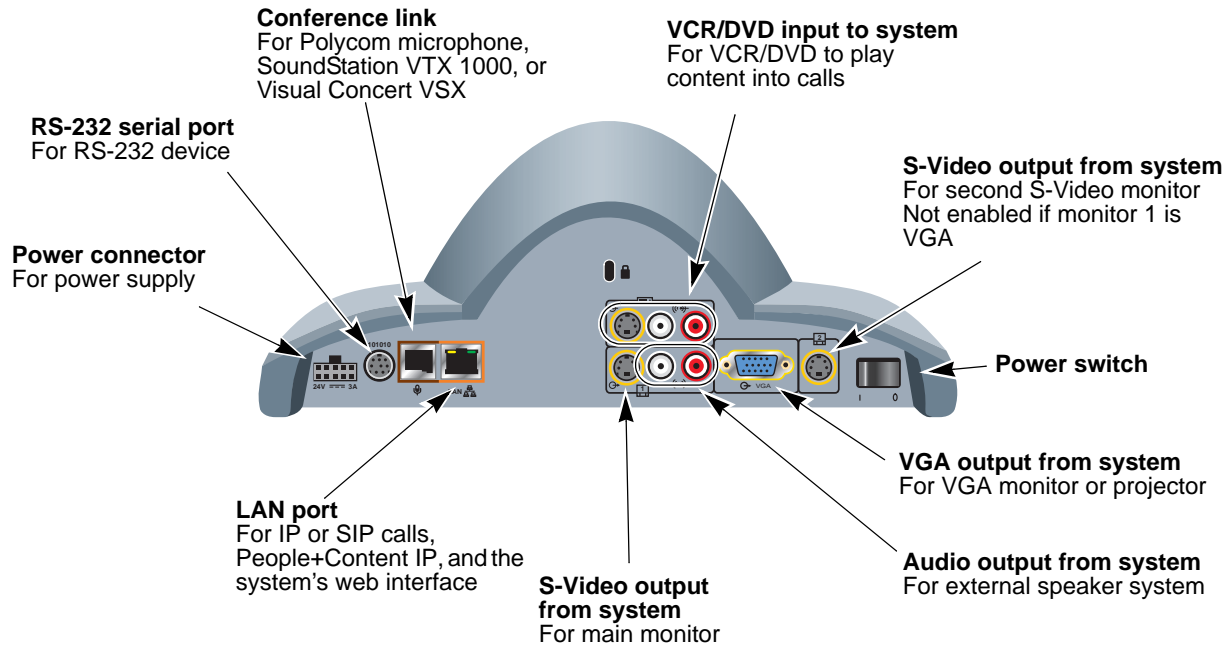

VSX 7000 Back Panel

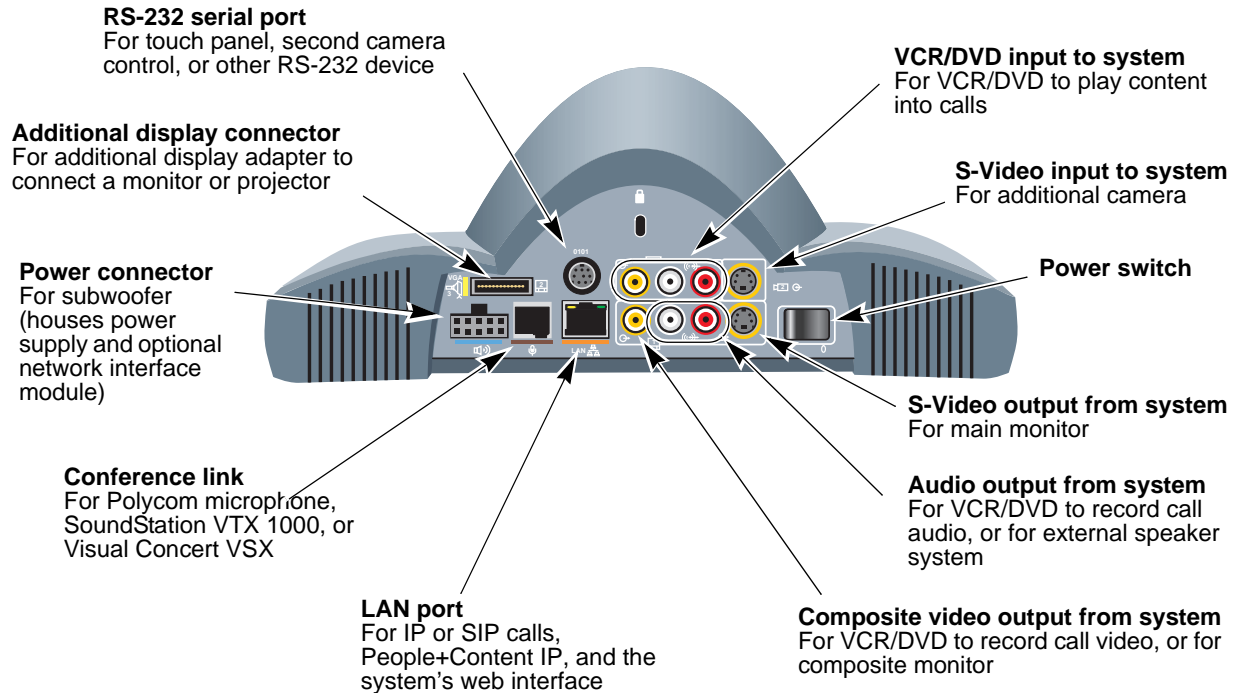

VSX 7000s Back Panel

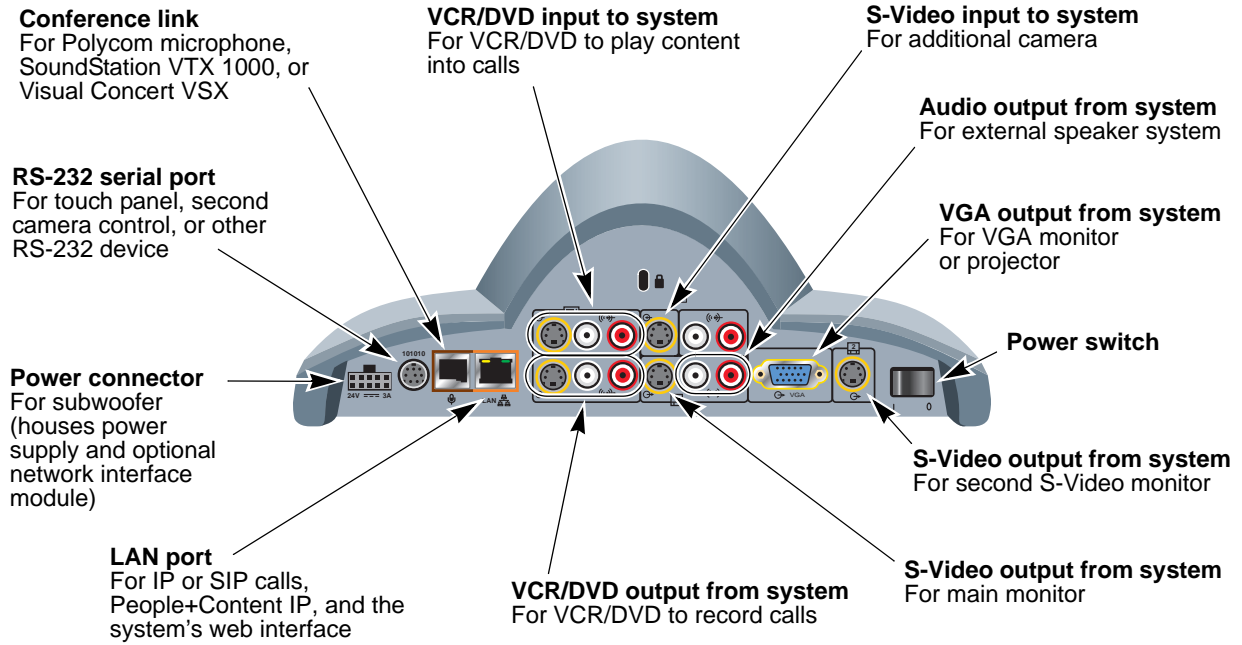

VSX 7000e Back Panel

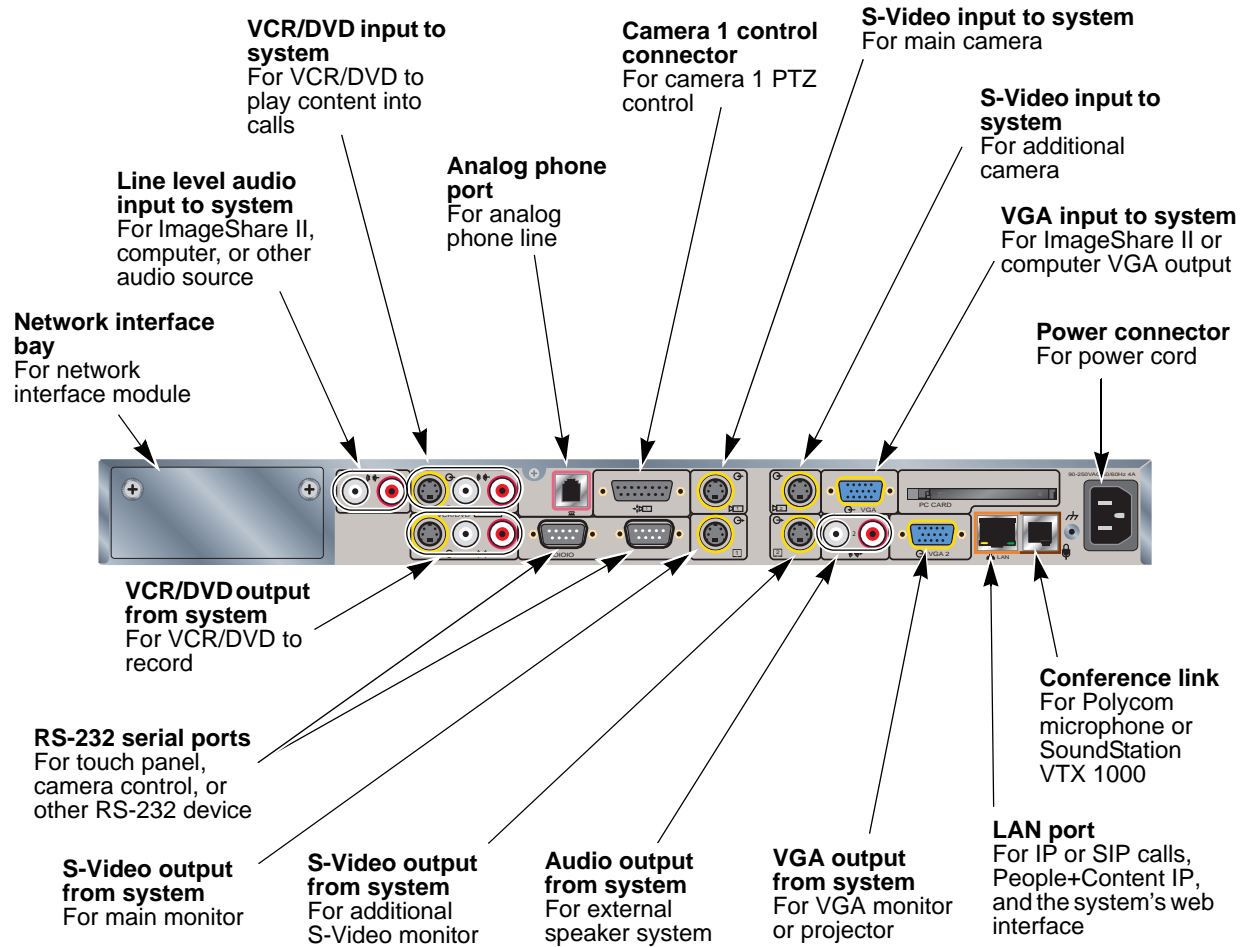



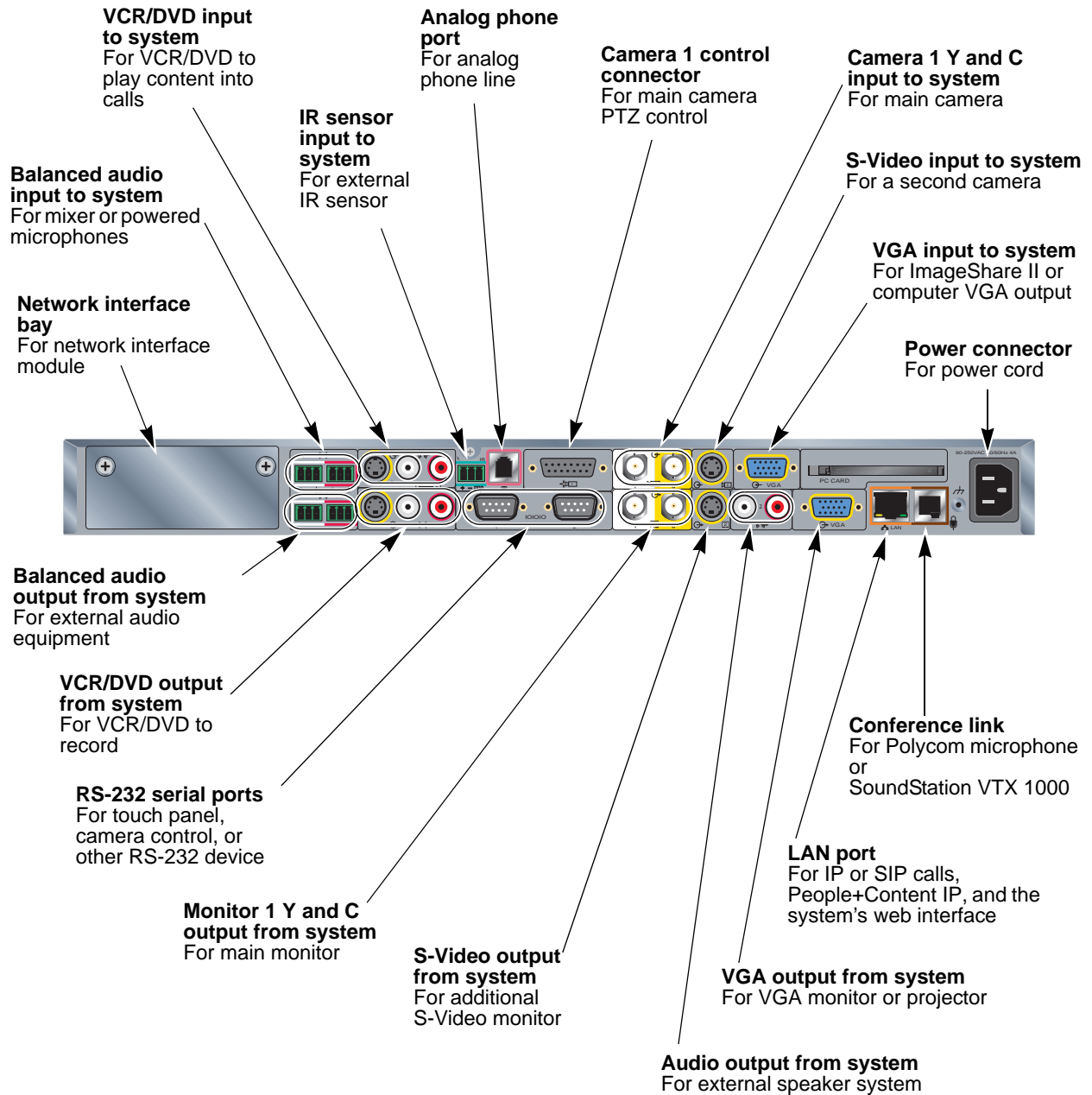







VSX 8000 Back Panel

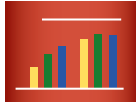

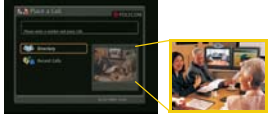









Video Source Output Examples for Multiple Monitors



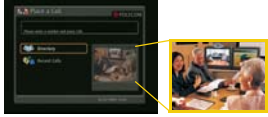

The following tables show how the monitor settings on your VSX system can affect what you see on your displays. You can configure the video sources for your displays in many ways; these tables show only a few typical configurations that are available on certain systems for point-to-point calls. Keep in mind that what you see on your displays can also be affected by multipoint display modes, dual monitor emulation, PIP settings, and so on. For more information about configuring video sources for each display, refer to the Monitor 1 and Monitor 2 video source settings described on page 3-2.

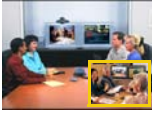

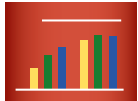

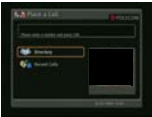
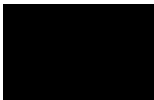
Select this:				To see this:		
	Near	Far	Content		Monitor 1 and PIP	Monitor 2
Monitor 1	<input checked="" type="checkbox"/>	<input checked="" type="checkbox"/>	<input checked="" type="checkbox"/>	Not in a call	Home screen and near video 	Near video 
Monitor 2	<input checked="" type="checkbox"/>	<input checked="" type="checkbox"/>	<input checked="" type="checkbox"/>	In a call without content	Far video 	Near video 
				In a call with content	Content and far video 	Content 

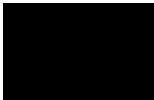

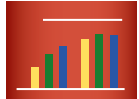

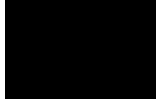

Select this:				To see this:		
	Near	Far	Content		Monitor 1 and PIP	Monitor 2
Monitor 1	<input checked="" type="checkbox"/>	<input checked="" type="checkbox"/>	<input type="checkbox"/>	Not in a call	Home screen with near video 	Near video 
Monitor 2	<input checked="" type="checkbox"/>	<input checked="" type="checkbox"/>	<input checked="" type="checkbox"/>	In a call without content	Far video 	Near video 
				In a call with content	Far video and near video 	Content 

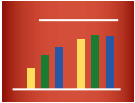



Select this:				To see this:		
	Near	Far	Content		Monitor 1 and PIP	Monitor 2
Monitor 1	<input checked="" type="checkbox"/>	<input checked="" type="checkbox"/>	<input type="checkbox"/>	Not in a call	Home screen with near video 	Near video 
Monitor 2	<input checked="" type="checkbox"/>	<input checked="" type="checkbox"/>	<input type="checkbox"/>	In a call without content	Far video 	Near video 
				In a call with content	Far video 	Near video 



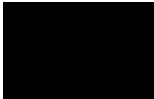

Select this:				To see this:		
	Near	Far	Content		Monitor 1 and PIP	Monitor 2
Monitor 1	<input checked="" type="checkbox"/>	<input checked="" type="checkbox"/>	<input type="checkbox"/>	Not in a call	Home screen with near video 	Black screen 
Monitor 2	<input type="checkbox"/>	<input checked="" type="checkbox"/>	<input checked="" type="checkbox"/>	In a call without content	Far video and near video 	Black screen 
				In a call with content	Far video and near video 	Content 

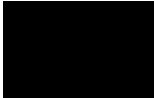
Select this:				To see this:		
	Near	Far	Content		Monitor 1 and PIP	Monitor 2
Monitor 1	<input type="checkbox"/>	<input checked="" type="checkbox"/>	<input type="checkbox"/>	Not in a call	Home screen 	Black screen 
Monitor 2	<input type="checkbox"/>	<input checked="" type="checkbox"/>	<input checked="" type="checkbox"/>	In a call without content	Far video 	Black screen 
				In a call with content	Far video 	Content 

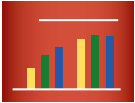
Select this:				To see this:		
	Near	Far	Content		Monitor 1 and PIP	Monitor 2
Monitor 1	<input type="checkbox"/>	<input type="checkbox"/>	<input type="checkbox"/>	Not in a call	Home screen 	Black screen 
Monitor 2	<input type="checkbox"/>	<input checked="" type="checkbox"/>	<input checked="" type="checkbox"/>	In a call without content	Near video 	Far video 
				In a call with content	Near video 	Content 

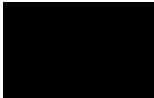
Select this:				To see this:		
	Near	Far	Content		Monitor 1 and PIP	Monitor 2
Monitor 1	<input type="checkbox"/>	<input type="checkbox"/>	<input type="checkbox"/>	Not in a call	Home screen 	Black screen 
Monitor 2	<input type="checkbox"/>	<input checked="" type="checkbox"/>	<input type="checkbox"/>	In a call without content	Near video 	Black screen 
				In a call with content	Near video 	Far video 

Select this:				To see this:		
	Near	Far	Content		Monitor 1 and PIP	Monitor 2
Monitor 1	<input type="checkbox"/>	<input type="checkbox"/>	<input type="checkbox"/>	Not in a call	Home screen 	Black screen 
Monitor 2	<input type="checkbox"/>	<input type="checkbox"/>	<input checked="" type="checkbox"/>	In a call without content	Near video 	Black screen 
				In a call with content	Near video 	Content 

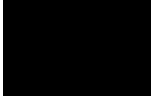
Select this:				To see this:		
	Near	Far	Content		Monitor 1 and PIP	Monitor 2
Monitor 1	<input type="checkbox"/>	<input type="checkbox"/>	<input type="checkbox"/>	Not in a call	Home screen 	Black screen 
Monitor 2	<input type="checkbox"/>	<input type="checkbox"/>	<input type="checkbox"/>	In a call without content	Near video 	Black screen 
				In a call with content	Near video 	Black screen 

Port Usage

You may need this information when you configure your network equipment for video conferencing.

The following table shows IP port usage.

Port	Function
80-Static	TCP HTTP interface (optional)
389-Static	TCP ILS registration (LDAP)
1503-Static	TCP T.120
1718-Static	TCP Gatekeeper discovery (must be bidirectional)
1719-Static	TCP Gatekeeper RAS (must be bidirectional)
1720-Static	TCP H.323 call setup (must be bidirectional)
1731-Static	TCP Audio call control (must be bidirectional)
5060-Static	UDP/TCP SIP call setup (must be bidirectional)
8080-Static	TCP HTTP server push (optional)
1024-65535	Dynamic TCP H245. Can be set to "Fixed Ports" on Polycom systems.
1024-65535	Dynamic UDP - RTP (video data). Can be set to "Fixed Ports" on Polycom systems.
1024-65535	Dynamic UDP - RTP (audio data). Can be set to "Fixed Ports" on Polycom systems.
1024-65535	Dynamic UDP - RTCP (control information). Can be set to "Fixed Ports" on Polycom systems.

The following table shows Global Management System port usage.

Port	Function
21	(FTP) Software upgrades and provisioning for VSX systems and ViewStations
24	Polycom API
80	(HTTP) Pulling VSX system, ViewStation, and VS4000 information
80	(HTTP) Software upgrades and provisioning for iPower™
123	UPD Network time protocol (NTP)
161-162	TCP/UDP SNMP
3601	(Proprietary - data traffic) - Global directory data
3603	TCP - Pulling ViaVideo® information (since might be non-web server computer)
389	LDAP and ILS Static - TCP/UDP ILS registration (LDAP)
443	TCP HTTPS
514	UDP syslog
636	Secure LDAP communication (LDAPS)
1002	ILS

The following table shows other VSX system port usage.

Port	Function
21	(FTP) Software upgrades and Global Management System provisioning
23	(Telnet) For diagnostics
24	(Telnet) API control

PathNavigator Error Codes and Q.850 Cause Codes

PathNavigator Error Codes

The following table lists PathNavigator error codes.

Code	Cause	Description
150	No Network Resources	The network does not have enough resources to complete your call. Try calling at a lower rate, or try the call again later.
151	No Network Resources	The network does not have enough resources to complete your call. Try calling at a lower rate, or try the call again later.
152	Gatekeeper Problems	Your call could not be completed because of an internal error in the gatekeeper or system. Contact the gatekeeper or system vendor for assistance.
153	Incorrect Address	Your call could not be completed because of an internal error in the gatekeeper or system. Contact the gatekeeper or system vendor for assistance.
154	Gatekeeper Problems	Your call could not be completed because of an internal error in the gatekeeper or system. Contact the gatekeeper or system vendor for assistance.
155	Gatekeeper Problems	Your call could not be completed because of an internal error in the gatekeeper or system. Contact the gatekeeper or system vendor for assistance.
156	Gatekeeper Problems	Your call was rejected by the gatekeeper. Contact your Network Administrator for assistance.

Code	Cause	Description
157	Gatekeeper Problems	Your call could not be completed because of an internal error in the gatekeeper or system. Contact the gatekeeper or system vendor for assistance.
158	Gatekeeper Problems	Your call could not be completed due to gatekeeper problems. Try the call again later.
159	System Not Registered with Gatekeeper	Your system must be registered with the gatekeeper before you can place a call. Contact your Network Administrator for assistance.
160	Far Site Not Registered with Gatekeeper	The system you are trying to call is not registered with the gatekeeper.
164	Far Site Busy	The system you called is busy. Try the call again later.
167	System Not Registered with Gatekeeper	Your system must be registered with the gatekeeper before you can place a call. Contact your Network Administrator for assistance.
168	Unknown Issues	Your call could not be completed due to an unknown problem. Try the call again later.
169	Call Rejected by Gatekeeper.	Your call was rejected by the gatekeeper. Contact your Network Administrator for assistance.
172	No Network Resources	The network does not have the necessary resources to complete your call. Try the call again later.
173	Site Not Found	The site you called could not be located. Check the calling information and try again.
174	Security/Permission Denial	Your call could not be completed because of security or permission issues. Contact your Network Administrator for assistance.
175	QoS Not Supported	The network cannot provide sufficient Quality of Service for your call. Contact your Network Administrator for assistance.
176	No Network Resources	The network does not have the necessary resources to complete your call. Try the call again later.
179	QoS Not Supported	The network cannot provide sufficient Quality of Service for your call. Contact your Network Administrator for assistance.
180	Invalid Address	The address you entered is not valid. Check the calling information and try again.

Code	Cause	Description
203	Call Rejected	The far site system did not accept the call. Check the calling information and try again.
204	Connection Problem	Your call cannot be completed because the far-end system is not compatible with the H.323 communication standards used by this system.
208	Invalid Address	The address you entered is not valid. Check the calling information and try again.
221	Far Site Busy	The system you called is busy. Try the call again later.
222	Site Not Responding	The site you called did not answer. Try the call again later.
255	ISDN command processing error	The ISDN signaling code has encountered an error processing an ISDN action. ISDN adapter busy-wait and retry.
516	Invalid Address	The address you entered is not valid. Check the calling information and try again.
518	Invalid Address	The address you entered is not valid. Check the calling information and try again.
521	Gatekeeper Problems	Your call could not be completed due to gatekeeper problems. Try the call again later.
531	Invalid Address	The address you entered is not valid. Check the calling information and try again.
534	Gatekeeper Problems	Your call could not be completed due to gatekeeper problems. Try the call again later.
551	Invalid Address	The address you entered is not valid. Check the calling information and try again.
552	Invalid Address	The address you entered is not valid. Check the calling information and try again.
553	Invalid Address	The address you entered is not valid. Check the calling information and try again.
554	Invalid Address	The address you entered is not valid. Check the calling information and try again.
576	Invalid Address	The address you entered is not valid. Check the calling information and try again.
595	Invalid Address	The address you entered is not valid. Check the calling information and try again.
596	Invalid Address	The address you entered is not valid. Check the calling information and try again.

Code	Cause	Description
621	Invalid Address	The address you entered is not valid. Check the calling information and try again.
626	Invalid Address	The address you entered is not valid. Check the calling information and try again.
627	Invalid Address	The address you entered is not valid. Check the calling information and try again.
648	No Network Resources	The network does not have the necessary resources to complete your call. Try the call again later.
681	No Network Resources	The network does not have the necessary resources to complete your call. Try the call again later.

Q.850 Cause Codes

The following table describes codes that the ISDN switch sends to the VSX system to indicate call status. Although the codes are standardized, each ISDN service provider defines them differently. Because of this, the definitions in the table may not exactly match the messages that you see.

Code	Cause	Definition
1	Unassigned number	The switch received the sent ISDN number in the correct format, but no destination equipment uses the number.
2	No route to specified transit network	The ISDN exchange does not recognize the intermediate network through which to route the call.
3	No route to destination	The intermediate network through which the call is routed does not serve the destination address.
6	Channel unacceptable	The specified channel does not provide adequate service quality to accept the requested connection.
7	Call awarded and delivered	The user is assigned an incoming call that is being connected to a call channel that has already been established for this user and this type of call.
16	Normal call clearing	The originator or receiver of the call has requested that it be cleared.
17	User busy	All B channels are in use; the called system acknowledges the connection request, but is unable to accept the call.

Code	Cause	Definition
18	No user responding	The destination equipment does not respond to the call, so the connection cannot be completed.
19	No answer from user (user alerted)	The destination equipment did not complete the connection within the prescribed time after responding to the connection request. The problem is at the remote end of the connection.
21	Call rejected	The destination equipment is capable of accepting the call, but has rejected it for an unknown reason.
22	Number changed	The ISDN number used to set up the call is no longer valid. (The diagnostic field of the message may return an alternate address assigned to the called equipment.)
26	Non-selected user clearing	The destination is capable of accepting the call, but did not assign it to the user.
27	Destination out of order	A signaling message cannot be delivered because the interface is not functioning correctly, and the destination cannot be reached. This condition might be temporary; for example, remote equipment might be turned off.
28	Invalid number format	Destination address was incomplete or presented in an unrecognizable format, which prevented the connection from being established.
29	Facility rejected	The network cannot provide the facility requested by the user.
30	Response to STATUS INQUIRY	The equipment returns this message when it receives a STATUS INQUIRY message.
31	Normal, unspecified	A normal event has occurred with no standard cause applying. No resulting action is required.
34	No circuit/channel available	The call cannot be taken because no appropriate channel is available to establish the connection.
38	Network out of order	A network problem prevented the call from reaching its destination. Attempts to reconnect will probably fail until the network problem is corrected.
41	Temporary failure	A network error occurred. The problem will be resolved shortly. Attempts to reconnect may succeed.
42	Switching equipment congestion	The destination cannot be reached because the network switching equipment is temporarily overloaded.

Code	Cause	Definition
43	Access information discarded	The requested access information cannot be provided by the network. The diagnostic message may explain the problem.
44	Requested circuit/channel not available	The remote equipment cannot provide the requested channel. This may be temporary.
47	Resource unavailable, unspecified	An unknown problem prevents the remote equipment from providing the requested resource.
49	Quality of service unavailable	The network cannot provide the requested quality of service (as defined by CCITT recommendation X.213). This may be a subscription problem.
50	Requested facility not subscribed	The remote equipment is capable of providing the requested supplementary service, but is not subscribed to it.
57	Bearer capability not authorized	The caller has requested a bearer capability that the network can provide, but the user is not authorized to use. This may be a subscription problem.
58	Bearer capability not presently available	The network normally provides the requested bearer capability, but cannot provide it now. This may be a temporary network problem or a subscription problem.
63	Service or option not available, unspecified	An unspecified problem prevents the network or remote equipment from providing the requested service or option. This might be a subscription problem.
65	Bearer capability not implemented	The network is not capable of providing the bearer capability requested by the user.
66	Channel type not implemented	The requested channel type is not supported by the equipment sending this code.
69	Requested facility not implemented	The remote equipment is not capable of providing the requested supplementary service.
70	Only restricted digital information bearer is available	The network is unable to provide unrestricted digital information over bearer capability.
79	Service or option not available, unspecified	The network or remote equipment is unable to provide the requested service option for an unspecified reason. This might be a subscription problem.

Code	Cause	Definition
81	Invalid call reference value	The remote equipment received a call with a call reference that is not currently in use on the user-network interface.
82	Identified channel does not exist	The receiving equipment is requested to use a channel that is not activated on the interface for calls.
83	A suspended call exists but this call identity does not	The network received a call resume request that contained a call identity information element that does not match any suspended call.
84	Call identity in use	The network received a call suspend request that contained a call identity information element for a call that is already suspended.
85	No call suspended	The network received a call resume request when there was not a suspended call pending. This might be a transient error that will be resolved by successive call retries.
86	Call having requested call identity has been cleared	The network received a call resume request containing a call identity information element for a call that was cleared while suspended, either by timeout or by the remote user.
88	Incompatible destination	Indicates that an attempt was made to connect to non-ISDN equipment, such as an analog line.
91	Invalid transit network specified	The ISDN exchange was asked to route the call through an unrecognized intermediate network.
95	Invalid message, unspecified	An invalid message was received, for an unknown reason. This is usually due to a D-channel error. If this error occurs systematically, report it to your ISDN service provider.
96	Mandatory information element is missing	The equipment received a message that did not include one of the mandatory information elements. This is usually due to a D-channel error. If this error occurs systematically, report it to your ISDN service provider.
97	Message type nonexistent or not implemented	The equipment received a message of a type that is invalid or not supported. This code indicates either a problem with the remote configuration or a problem with the local D channel.
98	Message incompatible with call state or message type nonexistent	The equipment received a message that is not valid in the current call state. Cause 98 is usually due to a D-channel error. If this error occurs systematically, report it to your ISDN service provider.

Code	Cause	Definition
99	Information element nonexistent or not implemented	The equipment received a message that includes information elements which were not recognized. This is usually due to a D-channel error. If this error occurs systematically, report it to your ISDN service provider.
100	Invalid information element contents	The equipment received a message that includes invalid information in the information element. This is usually due to a D-channel error.
101	Message not compatible with call state	The remote equipment received a message that does not correspond to the current state of the connection. This is usually due to a D-channel error.
102	Recovery on timer expiry	A time-out has triggered an error-handling (recovery) procedure. This problem is typically temporary.
111	Protocol error, unspecified	An unspecified D-channel error when no other standard cause applies.
127	Interworking, unspecified	An event occurred within a network that does not provide causes for the action that it takes. The precise problem is unknown.
145	ISDN layer 1 and/or 2 link not established	User needs to check cabling, ISDN adapter status, and network connections.
146	ISDN layer 3 connection to the ISDN switch/network inactive	There is either a switch protocol error, or (in the United States or Canada) a SPID assignment problem.
255	ISDN command processing error	The ISDN signaling code has encountered an error processing an ISDN action. ISDN adapter busy-wait and retry.

Multipoint Dialing Speed

In a multipoint call, all parties must be connected at the same speed.

The following table shows the maximum allowable dialing speeds for the number of sites, including the main site, in a call.

Number of Sites in a Call	With BRI Lines		With PRI Lines	H.323 Only
	Number of Lines	Max Speed for Each Site (Kbps)	Max Speed for Each Site (Kbps)	Max Speed for Each Site (Kbps)
2	2	256	1920	1920
2	3	384	1920	1920
2	4	512	1920	1920
3	2	128	512	512
3	3	192	512	512
3	4	256	512	512
4	2	64	384	384
4	3	128	384	384
4	4	128	384	384
5 (VSX 8000 only)	2	N/A	320	384
5 (VSX 8000 only)	3	64	320	384
5 (VSX 8000 only)	4	128	320	384
6 (VSX 8000 only)	2	N/A	256	384
6 (VSX 8000 only)	3	64	256	384
6 (VSX 8000 only)	4	64	256	384

Maximum speeds can be further limited by the communications equipment.

Regulatory Notices

Important Safeguards

Read and understand the following instructions before using the system:

- Close supervision is necessary when the system is used by or near children. Do not leave unattended while in use.
- Only use electrical extension cords with a current rating at least equal to that of the system.
- Always disconnect the system from power before cleaning and servicing and when not in use.
- Do not spray liquids directly onto the system when cleaning. Always apply the liquid first to a static free cloth.
- Do not immerse the system in any liquid or place any liquids on it.
- Do not disassemble this system. To reduce the risk of shock and to maintain the warranty on the system, a qualified technician must perform service or repair work.
- Connect this appliance to a grounded outlet.
- Only connect the system to surge protected power outlets.
- Keep ventilation openings free of any obstructions.
- If the system or any accessories are installed in an enclosed space such as a cabinet, ensure that the air temperature in the enclosure does not exceed 40°C (104° F). You may need to provide forced cooling to keep the equipment within its operating temperature range.

SAVE THESE INSTRUCTIONS.

Electrical Specifications

Polycom VSX 3000, VSX 3000A System:	100-240VAC, 47-63Hz, 1.9A, 80W max
Polycom VSX 5000 System:	(Potrans) 100-240VAC, 50-60Hz, 1.8A (Ault power supply) 100-240VAC, 50-60Hz, 1.3A
Polycom VSX 6000, VSX 6000A System:	(Potrans) 100-240VAC, 50-60Hz, 1.8A (Ault power supply) 100-240VAC, 50-60Hz, 1.3A
Polycom VSX 7000s System:	(Subwoofer) 100-240VAC, 50/60Hz, 1.1A
Polycom VSX 7000e System:	90-250VAC, 50/60Hz, 4A
Polycom VSX 8000 System:	90-250VAC, 50/60Hz, 4A

License Restrictions

THE SOFTWARE PROGRAMS CONTAINED OR DESCRIBED HEREIN ARE CONFIDENTIAL INFORMATION AND PROPRIETARY PRODUCTS OF POLYCOM, INC. OR ITS LICENSORS.

Buyer shall not sublicense or otherwise distribute any of the Subject Programs except to End Users and/or resellers who have entered into a Sublicense Agreement. For purposes of this Agreement a "Sublicense Agreement" shall mean a written license agreement between the Buyer and its purchaser, or, in the case of any sale by Buyer to a reseller, between such reseller and the End User, that is either 1) signed by the End User or 2) included with the Documentation, in such a manner that the End User reasonably indicates its acceptance of the Sublicense Agreement by turning on and using the Computer Equipment. Polycom, Inc. shall include so-called "break the seal software licenses" with the Documentation, and Buyer shall not remove or alter any such Sublicense Agreements or any notifications or warning stickers relating thereto. Buyer shall not waive, amend, or otherwise modify any Sublicense Agreement without Polycom's prior consent.

Title to all Subject Programs shall at all times remain and vest solely with Polycom, Inc. and its licensors. Buyer acknowledges Polycom's claim that the Subject Programs are its trade secret and confidential property, and shall treat them as such. Buyer will not attempt to disassemble, decompile, reverse-engineer or otherwise endeavor to discover or disclose the methods and concepts embodied in the Subject Programs. Except as expressly allowed under this Agreement, the Buyer shall not copy, modify, transcribe, store, translate, sell, lease, or otherwise transfer or distribute any of the Subject Programs in whole or in part, without prior authorization, in writing, from Polycom, Inc. Buyer shall not remove or destroy any copyright, patent, trademark or other proprietary mark or notice on Computer Equipment, and shall reproduce any such marks on any copies of Subject Programs that it makes hereunder.

You shall not, and shall not allow, any third party to 1) decompile, disassemble, or otherwise reverse-engineer or attempt to reconstruct or discover any source code or underlying ideas or algorithms of the software by any means whatsoever or 2) remove any product.

Warranty Information

LIMITED WARRANTY. Polycom warrants to the end user ("Customer") that the product will be free from defects in workmanship and materials, under normal use and service, for one year, or such longer period as Polycom may announce publicly from time to time for particular products, from the date of purchase from Polycom or its authorized reseller. This warranty covers the product acquired by the consumer including all of its accessories, components, and parts there to.

Polycom's sole obligation under this express warranty shall be, at Polycom's option and expense, to repair the defective product or part, deliver to Customer an equivalent product or part to replace the defective item, or if neither of the two foregoing options is reasonably available, Polycom may, in its sole discretion, refund to Customer the purchase price paid for the defective product. All products that are replaced will become the property of Polycom. Replacement products or parts may be new or reconditioned. Polycom warrants any replaced or repaired product or part for ninety (90) days from shipment, or the remainder of the initial warranty period, whichever is longer.

Products returned to Polycom must be sent prepaid and packaged appropriately for safe shipment, and it is recommended that they be insured or sent by a method that provides for tracking of the package. Responsibility for loss or damage does not transfer to Polycom until the returned item is received by Polycom. The repaired or replaced item will be shipped to Customer, at Polycom's expense, not later than thirty (30) days after Polycom receives the defective product, and Polycom will retain risk of loss or damage until the item is delivered to Customer.

Warranty Information

EXCLUSIONS. POLYCOM WILL NOT BE LIABLE UNDER THIS LIMITED WARRANTY IF ITS TESTING AND EXAMINATION DISCLOSE THAT THE ALLEGED DEFECT OR MALFUNCTION IN THE PRODUCT DOES NOT EXIST OR RESULTS FROM:

- FAILURE TO FOLLOW POLYCOM'S INSTALLATION, OPERATION, OR MAINTENANCE INSTRUCTIONS.
- UNAUTHORIZED PRODUCT MODIFICATION OR ALTERATION.
- UNAUTHORIZED USE OF COMMON CARRIER COMMUNICATION SERVICES ACCESSED THROUGH THE PRODUCT.
- ABUSE, MISUSE, NEGLIGENT ACTS OR OMISSIONS OF CUSTOMER AND PERSONS UNDER CUSTOMER'S CONTROL; OR
- ACTS OF THIRD PARTIES, ACTS OF GOD, ACCIDENT, FIRE, LIGHTING, POWER SURGES OR OUTAGES, OR OTHER HAZARDS.

WARRANTY EXCLUSIVE. IF A POLYCOM PRODUCT DOES NOT OPERATE AS WARRANTED ABOVE, CUSTOMER'S SOLE REMEDY FOR BREACH OF THAT WARRANTY SHALL BE REPAIR, REPLACEMENT, OR REFUND OF THE PURCHASE PRICE PAID, AT POLYCOM'S OPTION. TO THE FULL EXTENT ALLOWED BY LAW, THE FOREGOING WARRANTIES AND REMEDIES ARE EXCLUSIVE AND ARE IN LIEU OF ALL OTHER WARRANTIES, TERMS, OR CONDITIONS, EXPRESS OR IMPLIED, EITHER IN FACT OR BY OPERATION OF LAW, STATUTORY OR OTHERWISE, INCLUDING WARRANTIES, TERMS, OR CONDITIONS OF MERCHANTABILITY, FITNESS FOR A PARTICULAR PURPOSE, SATISFACTORY QUALITY, CORRESPONDENCE WITH DESCRIPTION, AND NON-INFRINGEMENT, ALL OF WHICH ARE EXPRESSLY DISCLAIMED. POLYCOM NEITHER ASSUMES NOR AUTHORIZES ANY OTHER PERSON TO ASSUME FOR IT ANY OTHER LIABILITY IN CONNECTION WITH THE SALE, INSTALLATION, MAINTENANCE OR USE OF ITS PRODUCTS.

SUPPORT & SERVICE AGREEMENTS. If you purchased your product from a Polycom Authorized Reseller, contact the Authorized Reseller for information about support and service agreements applicable to your product. For information on Polycom service, go to the Polycom web site www.polycom.com, products and services menu, or call 1-800-765-9266, outside the US call 1-408-526-9000, or your local Polycom Office, as listed on the Polycom Web site.

LIMITATION OF LIABILITY. TO THE FULL EXTENT ALLOWED BY LAW, POLYCOM EXCLUDES FOR ITSELF AND ITS SUPPLIERS ANY LIABILITY, WHETHER BASED IN CONTRACT OR TORT (INCLUDING NEGLIGENCE), FOR INCIDENTAL, CONSEQUENTIAL, INDIRECT, SPECIAL, OR PUNITIVE DAMAGES OF ANY KIND, OR FOR LOSS OF REVENUE OR PROFITS, LOSS OF BUSINESS, LOSS OF INFORMATION OR DATA, OR OTHER FINANCIAL LOSS ARISING OUT OF OR IN CONNECTION WITH THE SALE, INSTALLATION, MAINTENANCE, USE, PERFORMANCE, FAILURE, OR INTERRUPTION OF ITS PRODUCTS, EVEN IF POLYCOM OR ITS AUTHORIZED RESELLER HAS BEEN ADVISED OF THE POSSIBILITY OF SUCH DAMAGES, AND LIMITS ITS LIABILITY TO REPAIR, REPLACEMENT, OR REFUND OF THE PURCHASE PRICE PAID, AT POLYCOM'S OPTION. THIS DISCLAIMER OF LIABILITY FOR DAMAGES WILL NOT BE AFFECTED IF ANY REMEDY PROVIDED HEREIN SHALL FAIL OF ITS ESSENTIAL PURPOSE.

DISCLAIMER. Some countries, states, or provinces do not allow the exclusion or limitation of implied warranties or the limitation of incidental or consequential damages for certain products supplied to consumers, or the limitation of liability for personal injury, so the above limitations and exclusions may be limited in their application to you. When the implied warranties are not allowed to be excluded in their entirety, they will be limited to the duration of the applicable written warranty. This warranty gives you specific legal rights which may vary depending on local law.

GOVERNING LAW. This Limited Warranty and Limitation of Liability shall be governed by the laws of the State of California, U.S.A., and by the laws of the United States, excluding their conflicts of laws principles. The United Nations Convention on Contracts for the International Sale of Goods is hereby excluded in its entirety from application to this Limited Warranty and Limitation of Liability.

Regulatory Notices

Warning

This is a Class A product. In a domestic environment, this product may cause radio interference in which case the user may be required to take adequate measures.

USA and Canadian Regulatory Notices

FCC Notice

Class A Digital Device or Peripheral

This equipment has been tested and found to comply with the limits for a Class A digital device, pursuant to Part 15 of the FCC Rules. These limits are designed to provide reasonable protection against harmful interference when the equipment is operated in a commercial environment. This equipment generates, uses, and can radiate radio frequency energy and, if not installed and used in accordance with the instruction manual, may cause harmful interference to radio communications. Operation of this equipment in a residential area is likely to cause harmful interference in which case the user will be required to correct the interference at his own expense.

In accordance with Part 15 of the FCC rules, the user is cautioned that any changes or modifications not expressly approved by Polycom Inc. could void the user's authority to operate this equipment.

The socket outlet to which this apparatus is connected must be installed near the equipment and must always be readily accessible.

Part 15 FCC Rules

This device complies with part 15 of the FCC rules. Operation is subject to the following two conditions:

- 1) This device may not cause harmful interference, and
- 2) this device must accept any interference received, including interference that may cause undesired operation.

Part 68 FCC Rules

This equipment complies with part 68 of the FCC rules and the rules adopted by the ACTA. On the Network Interface Module of this equipment is a label that contains, among other information, a product identifier in the format US:AAAEQ#TXXX. If requested, this number must be provided to the telephone company.

This equipment may not be used on a coin service or party line.

If you experience trouble with your VSX system, disconnect it from the telephone line to determine if the registered equipment is malfunctioning. For repair or warranty information, please contact Polycom Inc. at 1-888-248-4143 or 4750 Willow Road, Pleasanton, CA 94588-2708, USA. Contact information may also be found at <http://www.polycom.com>. If the system is causing harm to the network, the telephone company may request that you disconnect it until the problem is corrected.

If your VSX system causes harm to the telephone network, the telephone company will notify you in advance that temporary discontinuance of service may be required. However, if advance notice is not practical, you will be notified as soon as possible. You will be advised of your right to file a complaint with the FCC if you believe it is necessary.

Your telephone company may make changes in its facilities, equipment, operations, or procedures that could affect the operation of your equipment. If they do, you will be given advance notice so that you may make any changes necessary to maintain uninterrupted service.

The REN is useful to determine the quantity of devices that may be connected to the telephone line. Excessive RENs on the telephone line may result in the devices not ringing in response to an incoming call. In most, but not all areas, the sum of RENs of all devices that may be connected to a line, is determined by the total RENs, contact the local telephone company.

Regulatory Notices

FCC compliant telephone cords and modular plugs are provided with this equipment. This equipment is designed to be connected to the telephone network or premises' wiring using a compatible modular jack, which is Part 68 compliant. See installation instructions for details.

WHEN PROGRAMMING EMERGENCY NUMBERS AND/OR MAKING TEST CALLS TO EMERGENCY NUMBERS:

- 1) Remain on the line and briefly explain to the dispatcher the reason for the call.
- 2) Perform such activities in the off-peak hours, such as early morning or late evening.

Industry Canada (IC)

This Class [A] digital apparatus complies with Canadian ICES-003.

Cet appareil numérique de la Classe [A] est conforme à la norme NMB-003 du Canada.

The Industry Canada label identifies certified equipment. This certification means that the equipment meets telecommunications network protective, operational and safety requirements as prescribed in the appropriate Terminal Equipment Technical Requirements document(s). The Department does not guarantee the equipment will operate to the user's satisfaction.

Before installing this equipment, users should ensure that it is permissible to be connected to the facilities of the local telecommunications company. The equipment must also be installed using an acceptable method of connection. The customer should be aware that compliance with the above conditions may not prevent degradation of service in some situations. Repairs to certified equipment should be coordinated by a representative designated by the supplier. Any repairs or alterations made by the user to this equipment, or equipment malfunctions, may give the telecommunications company cause to request the user to disconnect the equipment.

Users should ensure for their own protection that the electrical ground connections of the power utility, telephone lines and internal metallic water pipe system, if present, are connected together. This precaution may be particularly important in rural areas.

Caution: Users should not attempt to make such connections themselves, but should contact the appropriate electric inspection authority, or electrician, as appropriate.

The Ringer Equivalence Number (REN) assigned to each relevant terminal device provides an indication of the maximum number of terminals allowed to be connected to a telephone interface. The termination on an interface may consist of any combination of devices subject only to the requirement that the sum of the RENs of all the devices does not exceed 5.

The REN of this equipment is either marked on the unit or included in the new style USA FCC registration number. In the case that the REN is included in the FCC number, the user should use the following key to determine the value:

The FCC number is formatted as US:AAAEQ#TXXX.

is the Ringer Equivalence Number without a decimal point (e.g. REN of 1.0 will be shown as 10, REN of 0.3 will be shown as 03). In the case of a Z ringer, ZZ shall appear. In the case of approved equipment without a network interface or equipment not to be connected to circuits with analog ringing supplied, NA shall appear.

Regulatory Notices

Mexican Regulatory Notices

Información del contacto para el importador de México
Polycom MÉXICO
Paseo de los Tamarindos
400-A 5to piso Suite: 21
Bosques de las Lomas
Cuajimalpa 05120 México, D.F.
Teléfono: +52-55-5091-4341
Fax: +52-55-5091-4472

EEA Regulatory Notices

CE Mark R & TTE Directive

This VSX system has been marked with the CE mark. This mark indicates compliance with EEC Directives 89/336/EEC, 73/23/EEC 1999/5/EC. A full copy of the Declaration of Conformity can be obtained from Polycom Ltd., 270 Bath Road, Slough UK SL1 4DX.

Declaration of Conformity:

Hereby, Polycom Ltd. declares that this VSX system is in compliance with the essential requirements and other relevant provisions of Directive 1999/5/EC.

Konformitetserklæring:

Hermed erklærer Polycom Ltd., at indestående VSX system er i overensstemmelse med de grundlæggende krav og de relevante punkter i direktiv 1999/5/EF.

Konformitätserklärung:

Hiermit erklärt Polycom Ltd., dass der VSX system die grundlegenden Anforderungen und sonstige maßgebliche Bestimmungen der Richtlinie 1999/5/EG erfüllt.

Δήλωση Συμμόρφωσης:

Δια του παρόντος, η εταιρεία Polycom Ltd. δηλώνει ότι η παρούσα συσκευή (δρομολογητής) VSX System; πληροί τις βασικές απαιτήσεις και άλλες βασικές προϋποθέσεις της Οδηγίας 1999/5/EK.

Vaatumusten mukaisuusvakuutus:

Polycom Ltd. vakuuttaa täten, että VSX system on direktiivin 1999/5/EC keskeisten vaatimusten ja sen muiden tätä koskevien säännösten mukainen.

Déclaration de conformité:

Par la présente, Polycom Ltd. déclare que ce VSX system est conforme aux conditions essentielles et à toute autre modalité pertinente de la Directive 1999/5/CE.

Dichiarazione di conformità:

Con la presente Polycom Ltd. dichiara che il VSX system soddisfa i requisiti essenziali e le altre disposizioni pertinenti della direttiva 1999/5/CE.

Verklaring van overeenstemming:

Hierbij verklaart Polycom Ltd. dat diens VSX system voldoet aan de basisvereisten en andere relevante voorwaarden van EG-richtlijn 1999/5/EG.

Regulatory Notices

Declaração de Conformidade:

Através da presente, a Polycom Ltd. declara que este VSX system se encontra em conformidade com os requisitos essenciais e outras disposições relevantes da Directiva 1999/5/CE.

Declaración de conformidad:

Por la presente declaración, Polycom Ltd. declara que este VSX system cumple los requisitos esenciales y otras cláusulas importantes de la directiva 1999/5/CE.

Överensstämmelseförklaring:

Polycom Ltd. förklarar härmed att denna VSX system överensstämmer med de väsentliga kraven och övriga relevanta stadganden i direktiv 1999/5/EG.

CE Mark LVD and EMC Directive

This VSX system has been marked with the CE mark. This mark indicates compliance with EEC Directives 89/336/EEC and 73/23/EEC. A full copy of the Declaration of Conformity can be obtained from Polycom Ltd., 270 Bath Road, Slough UK SL1 4DX, UK.

Mains Powered POTS Voice Telephony Without Emergency 000 Dialing

Warning: This equipment will be inoperable when mains power fails.

この装置は、情報処理装置等電波障害自主規制協議会（VCCI）の基準に基づくクラスA情報技術装置です。この装置を家庭環境で使用すると電波妨害を引き起こすことがあります。この場合には使用者が適切な対策を講ずるよう要求されることがあります。

声 明

此为A级产品，在生活环境中，该产品可能会造成无线电干扰。在这种情况下，可能需要用户对其干扰采取切实可行的措施。

A급 기기 (업무용 정보통신기기)

이 기기는 업무용으로 전자파적합등록을 한 기기이오니 판매자 또는 사용자는 이 점을 주의하시기 바라며, 만약 잘못판매 또는 구입하였을 때에는 가정용으로 교환하시기 바랍니다.

Underwriters Laboratories Statement

The system is intended to be powered only by the supplied power supply unit.

Special Safety Instructions

Follow existing safety instructions and observe all safeguards as directed.

Regulatory Notices

Installation Instructions

Installation must be performed in accordance with all relevant national wiring rules.

故障の原因となりますので、システムの電源がオンになっているときは、マイク入力への機器の接続や取り外しをしないでください。

Plug Acts as Disconnect Device

The socket outlet to which this apparatus is connected must be installed near the equipment and must always be readily accessible.

Restriction of Hazardous Substances Directive (RoHS)

Polycom products are RoHS compliant, which means we have eliminated or brought to within acceptable limits: Lead, Mercury, Cadmium, Hexavalent Chromium, Polybrominated Biphenyls, and Polybrominated Diphenylethers. All Polycom products are also marked with the universally recognized "recycle" symbol and we are in compliance with European WEEE regulation.

End of Life Products

Polycom encourages you to recycle your end-of-life Polycom products in an environmentally considerate way.

Battery Guidelines

Battery Usage

Observe battery polarity when you install or replace batteries in the remote control.

Replace batteries as a complete set, using new, quality batteries of the correct size and rating.

Do not short circuit batteries.

Batteries should be treated and used in accordance with the battery manufacturers guidance.

Battery Disposal



When the remote control batteries have reached the end of their working life, remove them and take them to a collection point where they can be recycled or disposed of in an environmentally friendly manner. Do not dispose of batteries in unsorted municipal waste.

Do not dispose of batteries in the fire.

Index

A

access

- allowing 7-4, 8-3, 8-5
- levels 7-3, 8-5
- limiting 1-6, 6-6, 7-3, 7-4, 8-2, 8-3, 8-4, 8-5
- remote 8-3

access code, ISDN, for international calls 7-1

access levels 7-3, 8-5

account number

- recorded in CDR 9-5
- requiring 9-5
- validating 9-5

Account Validation (screen) 9-5

adapters

- composite video 3-5
- null modem 5-10

Address Displayed in Global Directory (setting) 2-13

addresses

- directory, displaying 2-13
- displaying 7-5
- Global Directory Server 6-8
- IP 2-2
- IP multicast 6-11
- NAT public (WAN) 2-13
- primary gatekeeper 2-5
- SIP proxy server 2-9
- SIP registrar server 2-9

adjusting

- audio line in volume 4-11
- bass volume 4-13
- camera brightness 3-12
- DTR pulse duration 2-24
- monitor color balance 3-10
- sound effects volume 12-20
- subwoofer volume 4-13
- treble volume 4-13
- volume 4-13, 12-20

AES encryption

- enabling 8-8
- See also* encryption

AES Encryption (setting) 8-3, 8-8

alert tones 4-9, 7-9

Allow Access to User Settings (setting) 8-3, 8-5

Allow Directory Changes (setting) 6-6

Allow Mixed IP and ISDN Calls (setting) 6-1

Allow Streaming (setting) 6-10

Allow Video Display on Web (setting) 8-3, 9-2

Always Dial Area Code (setting) 6-9

analog phone

- configuring 2-27
- number 2-26

Answer on DSR (setting) 2-24

answering calls automatically 3-8, 6-2, 6-3

Appearance (screen) 7-7, 7-11

Area Code (setting) 2-8, 2-20, 2-21, 2-23

Area Code Required (setting) 7-1

aspect ratio

- monitor 1 3-2
- monitor 2 3-3

audio

balanced, configuring 4-11

configuring 4-9, 4-16

configuring equipment type 4-11

configuring for sharing content 5-7

configuring for VCR/DVD 4-12

configuring for Visual Concert VSX or
ImageShare II 4-12

guidelines for using Polycom microphones 4-1

guidelines for using SoundStation VTX 1000
4-1

ImageShare II or Visual Concert VSX output
5-7

LiveMusicMode 4-10

mixer, *See* Vortex mixer

port, web streaming 6-11

sound effects volume 4-9

StereoSurround 4-10

subwoofer 4-13

testing 11-5

troubleshooting 12-20

VCR/DVD settings 3-12, 5-2, 5-3

Audio Meter screen 11-5

- Audio Port (setting) 6-11
- Audio Protocol (setting), for broadcasting 2-25
- Audio Settings (screen) 4-9, 5-7
- Authentication Name, SIP 2-9
- Authentication PIN (setting) 2-5
- Auto Adjust for Daylight Saving Time (setting) 7-2
- Auto BRI Configuration (setting) 2-20
- Auto mode (multipoint display) 3-8
- Auto-Answer Multipoint Video (setting) 3-8, 6-2, 6-3
- Auto-Answer Point to Point Video (setting) 6-2, 6-3
- auto-answer, muting 4-9
- automatic camera tracking
 - calibrating 3-13, 3-14
 - configuring 3-14
 - setting up 3-11
 - troubleshooting 12-18
- Automatic Camera Tracking to Presets (setting) 3-14
- automatic restart, actions that cause 2-2, 2-3, 8-3
- automatically detect SPIDs 2-20
- Avaya network integration 2-6

B

- back panel view
 - VSX 3000A A-1
 - VSX 5000 A-2
 - VSX 6000 A-3
 - VSX 6000A A-4
 - VSX 7000 A-5, A-6
 - VSX 7000e A-7
 - VSX 7000s A-6
 - VSX 8000 A-8
- Backlight Compensation (setting) 3-12
- balanced audio, configuring 4-11
- Balanced Out (600 ohms) (setting) 4-12
- bandwidth
 - allowing users to specify 7-4
 - dynamic 2-11
 - managing 2-8, 2-11, 2-29
 - specifying 2-11
 - specifying allocations for People and Content 5-6
- Bandwidth (screen) 2-11
- bandwidth, *See also* call speed
- basic mode 2-27, 12-2
- Basic Mode (setting) 12-2
- bass adjustment 4-13

- battery icon 12-24
- Baud Rate (setting) 10-3
- Bonding (setting) 2-21
- BRI network interface
 - capabilities 2-15
 - channels to dial in parallel 2-19
 - configuring 2-19, 2-20
 - connecting to set-top and component systems 2-16
 - connecting to VSX 3000 and VSX 3000A 2-15
 - enabling/disabling lines 2-20
 - hardware requirements 2-15, 2-17
 - lights 2-17
 - specifying B1 and B2 channel numbers 2-20
 - voice algorithm 2-20
- brightness, camera 3-12
- broadcast mode
 - configuring 2-25
 - enabling 2-25
- browser, configuring to use the system's web interface 9-1
- burn-in prevention for monitors 3-9

C

- cable connections A-1, A-2, A-3, A-4, A-5, A-6, A-7, A-8
- cables
 - conference link (lengths and part numbers) 4-2, 5-4
 - for Visual Concert VSX 5-4
 - VSX to VTX (lengths and part numbers) 5-5
- calendar, accessing with the remote control 10-1
- calibrating automatic camera tracking 3-14
- call
 - statistics 11-3
 - status 11-3
 - status tools 11-2
 - type, statistics 11-3
- Call Detail Report (CDR)
 - account numbers 9-5
 - archives 11-10
 - description 11-6
 - information provided 11-7
- Call Detail Report (screen) 11-7
- Call Detail Report (setting) 6-2, 7-5
- Call Preference (screen) 2-27, 5-7
- call progress indicators 11-3
- Call Quality (setting) 2-29, 7-4
- Call Settings (screen) 6-1, 6-3

- call speed
 - allowing users to specify 7-4
 - for bonding calls 12-11
 - for streaming calls 6-10
 - multipoint calls E-1
 - serial V.35/RS-449/RS-530 2-24
 - setting gateway prefixes/suffixes 2-8
 - setting preferences 2-29
- call speed, *See also* bandwidth
- Call Speeds (screen) 2-29
- call statistics
 - accessing with the remote control 10-1
- Call Status screen 11-3
- Call Summary (screen) 11-3
- call type
 - allowing users to specify 7-4
- Call-by-Call (setting) 2-22
- Calling Profile (setting) 2-24
- calls
 - analog voice-only, enabling 2-28
 - answer mode 6-3
 - auto-answer 3-8, 6-2, 6-3
 - auto-answer, muting 4-9
 - basic troubleshooting 12-1
 - bonding, troubleshooting 12-11
 - cascaded 6-5
 - do not disturb 7-5
 - elapsed time, displaying 7-2
 - history, *See* Call Detail Report (CDR)
 - ISDN voice-only, enabling 2-28
 - mixed, allowing 6-1
 - multipoint, *See* multipoint calls
 - preferences, configuring 2-27
 - progress indicators 12-9, 12-11
 - quality, troubleshooting 12-15, 12-16
 - recent 7-5, 11-6
 - refusing, *See* Do Not Disturb
 - streaming 6-11
 - test 12-1
 - time, maximum 6-1
 - tracking 9-5
 - type 7-4
 - unaccepted 12-10
 - unknown type 12-10
- Camera Brightness (setting) 3-12
- Camera Calibration (screen) 3-13, 3-14
- Camera Direction (setting) 3-12, 3-13
- camera presets
 - deleting 3-16
 - setting 3-15, 3-16
 - tracking to 3-14
- Camera Settings (screen) 3-13, 3-14
- cameras
 - additional, configuring 3-13
 - automatic tracking with PowerCam Plus 3-11, 3-14
 - backlight compensation 3-12
 - brightness, adjusting 3-12
 - configuring 3-12–3-16
 - connecting 3-11
 - control, configuring 10-3
 - customizing icons 3-13, 3-14, 7-9
 - customizing names 3-13, 3-14, 7-9
 - direction of movement, specifying 3-12
 - far control of near camera 3-12
 - positioning 1-2
 - primary, specifying 3-12
 - setting presets 3-15
 - troubleshooting 12-17, 12-18
 - voice tracking with PowerCam Plus 3-14
- Cameras (screen) 3-12, 7-9
- cascaded calls
 - placing 6-5
 - restrictions 6-5
- channels to dial in parallel 2-19, 2-22
- Chinese Virtual Keyboard (setting) 10-1
- Click2Call
 - Lotus Sametime or Lotus Notes 2-10
- Clock Source (read-only setting) 2-23
- closed captions
 - configuring RS-232 serial port 5-10
 - configuring the modem 5-10
 - configuring to receive 10-3
 - providing audio to the captioner 5-9
 - providing by modem 5-9
 - providing by Telnet session 5-12
 - providing using the system's web interface 5-11
 - providing with equipment connected locally 5-10
 - RS-232 serial port configuration 5-10
 - troubleshooting 12-14
 - ways to provide 5-9
- color balance adjustment 3-10
- color bar test 3-10, 11-4
- computers
 - sharing content by connecting to system 5-5
 - sharing content using ImageShare II 5-5
 - sharing content using Visual Concert VSX 5-3
 - VSX 3000 as computer monitor 3-1
 - VSX 3000A as computer monitor 3-1
- conference link cable
 - lengths and part numbers 4-2, 5-4

- Conference On Demand 2-6
 - configuring VSX systems to use 6-4
 - multipoint calls 2-6
 - restrictions 6-4
 - conference phone, *See* SoundStation VTX 1000
 - configuring
 - audio
 - Audio screen 4-16
 - for content 5-2, 5-7
 - for recording calls 5-2, 5-3
 - general settings 4-9
 - balanced audio inputs 4-11
 - BRI 2-19, 2-20
 - call answering mode 6-3
 - call preferences 2-27
 - call settings 6-1
 - camera control 10-3
 - cameras 3-12–3-16
 - content display 5-6, 5-7
 - directory settings 6-6
 - dual monitor emulation 3-6
 - firewalls 2-12, 2-13
 - for analog phone 2-26, 2-27
 - for closed captions 10-3
 - for PathNavigator 6-4
 - for SoundStation VTX 1000 2-26
 - for VPN 2-13
 - ImageShare II 5-7
 - IP network 2-4–2-13
 - ISDN dialing rules 6-9
 - LAN properties 2-2, 2-3
 - LiveMusicMode 4-10
 - microphones
 - Polycom 4-9
 - powered 4-11, 4-16
 - modem
 - to receive closed captions 5-10
 - monitor settings 3-2
 - monitors
 - color, sharpness, brightness 3-10
 - for dual monitor emulation 3-7
 - multipoint calls 3-8
 - NAT 2-12, 2-13
 - network, using the setup wizard 1-6
 - PIP 3-5
 - PRI 2-21, 2-22, 2-23
 - remote control 10-1
 - serial V.35/RS-449/RS-530 2-24, 2-25
 - signal polarity, serial V.35/RS-449/RS-530
 - 2-24
 - SIP 2-9
 - SNMP 9-7
 - speakers 4-13
 - StereoSurround 4-10, 4-14
 - subwoofer 4-13
 - to use a gatekeeper 2-5
 - to use a gateway 2-8
 - to use Global Directory 6-8
 - touch-panel control 10-3
 - VCR/DVD 5-2, 5-3
 - video to be recorded 3-5
 - Visual Concert VSX 5-7
 - Vortex mixer 4-15, 10-3
 - web streaming 6-10
 - Confirm Directory Additions Upon Call
 - Disconnect (setting) 6-6
 - Confirm Directory Deletions (setting) 6-6
 - Connect to my LAN (setting) 2-2
 - connectivity tests 11-4
 - connectors
 - VSX 3000A back panel A-1
 - VSX 5000 back panel A-2
 - VSX 6000 back panel A-3
 - VSX 6000A back panel A-4
 - VSX 7000 back panel A-5, A-6
 - VSX 7000e back panel A-7
 - VSX 7000s back panel A-6
 - VSX 8000 back panel A-8
 - Console IP Address (setting) 9-8
 - contact list
 - home screen display 7-6
 - Contact List (setting) 7-4
 - Contact Name (setting) 9-7
 - content
 - audio, troubleshooting 12-21
 - display, configuring 3-5, 3-6, 5-6, 5-7
 - display, troubleshooting 5-7, 12-14
 - sending when computer connects 5-6
 - control panel 10-2
 - Country (setting) 7-1
 - Country Code (setting) 2-8, 7-1
 - Crypto Resync (setting) 2-25
 - cryptographic equipment, configuring to use
 - 2-25
 - CSU (channel service unit) 2-21
 - CTS signal polarity 2-24
- D**
- D Channel Location (read-only setting) 2-23
 - data collaboration, *See* sharing content

- date and time
 - displaying 7-5
 - setting 7-1
 - Date Format (setting) 7-2
 - daylight saving time adjustment 7-2
 - DCD signal polarity 2-24
 - Default Gateway (setting) 2-3
 - Delayed DCD Hangup (setting) 2-24
 - diagnostics 11-5
 - audio meter 11-5
 - color bar test 3-10, 11-4
 - IP connectivity tests 11-4
 - near end loop 11-4
 - network and call status tools 11-2
 - reset and restart 11-5
 - Dial 1+ for all USA Calls (setting) 6-9
 - dialing
 - last number dialed 7-5
 - multipoint speed information E-1
 - order 2-28
 - preferred method 2-28
 - RS-366 2-23
 - rules 6-9
 - speed dialing 7-5
 - Dialing Display (setting) 7-4
 - Dialing Order (setting) 2-28, 2-29
 - dialing prefix
 - ISDN or analog, for outside line 2-26
 - ISDN, for international calls 2-22
 - ISDN, for outside line 2-19, 2-21
 - serial V.35/RS-449/RS-530, for outside line 2-24
 - Dialing Rules (screen) 6-9
 - DiffServ 2-11
 - Direct Inward Dial (setting) 2-8
 - directory
 - allowing access 7-4
 - allowing changes 6-6
 - confirm changes 6-6
 - creating localized entry names 6-8
 - downloading to a computer 6-7
 - localized entries 6-8
 - managing with the system's web interface 6-7
 - settings 6-6
 - uploading from a computer 6-7
 - Directory (screen) 6-6
 - Directory (setting) 7-4
 - Directory Numbers (setting) 2-20
 - Directory Servers (screen) 6-8
 - Discussion mode (multipoint display) 3-8
 - Display Global Addresses (setting) 6-8
 - Display H.323 Extension (setting) 2-4
 - Display Icons in a Call (setting) 3-6
 - display modes, multipoint
 - auto 3-8
 - discussion 3-8
 - full screen 3-8
 - presentation 3-8
 - voice-activated switching 3-8
 - Display Name in Global Directory (setting) 6-8
 - Display Time in Call (setting) 6-2, 7-2
 - displays
 - VSX 3000 as computer monitor 3-1
 - VSX 3000A as computer monitor 3-1
 - displays, *See also* monitors
 - DNS name
 - Global Directory Server 6-8
 - SIP proxy server 2-9
 - SIP registrar server 2-9
 - system 2-2
 - DNS Servers (setting) 2-3
 - Do Not Disturb (setting) 6-3
 - Do Not Disturb Icon (setting) 7-5
 - Domain Name (setting) 2-2
 - DSR signal polarity 2-24
 - DTMF tones 10-1
 - DTR Pulse Duration (setting) 2-24
 - DTR signal polarity 2-24
 - dual monitor emulation
 - configuring 3-7
 - description 3-7
 - Dual Monitor Emulation (setting) 3-6
 - Duplex Mode (setting) 2-3
 - DVD/VCR, *See* VCR/DVD
 - Dynamic Bandwidth (setting) 2-11
- ## E
- E.164 alias 2-8
 - E.164 extension 2-4, 2-5, 2-8
 - echo cancellation
 - not compatible with Vortex mixer 4-11
 - Echo Canceller (setting) 4-11, 4-15, 4-16
 - Edgewater NAT/Firewall Solution 2-13
 - elapsed time, displaying 6-2, 7-2
 - Enable Analog Phone (setting) 2-28
 - Enable Basic Mode (setting) 2-27, 12-2
 - Enable Broadcast Mode (setting) 2-25
 - Enable H.239 (setting) 2-27, 5-7
 - Enable H.460 Firewall Traversal setting 2-12
 - Enable Internal Ringer (setting) 4-9, 7-9, A-1

Enable IP H.323 (setting) 2-27
 Enable ISDN Gateway setting 2-28
 Enable ISDN H.320 (setting) 2-19, 2-21, 2-27
 Enable Multipoint Trial (setting) 6-4
 Enable People+Content (setting) 2-25
 Enable Phantom Power (setting) 4-11, 4-16
 Enable Polycom Live Music Mode (setting) 4-10
 Enable Polycom Microphones (setting) 4-9, 4-15
 Enable Polycom StereoSurround (setting) 4-10, 4-14
 Enable PVEC (setting) 2-11
 Enable Remote Access (setting) 8-3
 Enable RSVP (setting) 2-11
 Enable SIP (setting) 2-27
 Enable SNMP (setting) 9-7
 Enable Streaming Announcement (setting) 6-10
 Enable V.35/RS-449/RS-530 (setting) 2-23, 2-28
 Enable Voice Over ISDN (setting) 2-28
 encryption
 enabling 8-3, 8-8
 information in Call Statistics 11-3
 Enter IP Address Manually (setting) 2-2
 error concealment 2-11
 extensions
 E.164 2-4, 2-5, 2-8
 entering on home screen 7-4
 H.323 2-4, 2-5, 2-8, 7-4
 External CSU (setting) 2-21
 external CSU cable length 2-22
 external IR sensor 10-2
 external speaker system, *See* speakers

F

Far Control of Near Camera (setting) 3-12
 far site
 allowing to control near camera 3-12
 system information 11-3
 Far Site Name Display Time (setting) 6-2
 feet, installing 1-4
 Firewall (screen) 2-12
 firewalls
 configuring 2-12, 2-13
 traversal feature 2-13
 See also NAT and security
 Fixed Ports (setting) 2-12
 Frame Rate (setting), for broadcasting 2-25
 FTP access, controlling 8-3
 Full screen mode (multipoint display) 3-8

G

gatekeeper
 IP address 2-5
 name 2-5
 specifying 2-5
 Gatekeeper (screen) 2-5
 gateway
 call speed prefix/suffix 2-8
 configuring to use 2-8
 default 2-3
 specifying number 2-8
 Gateway (screen) 2-8
 Gateway Number Type (setting) 2-8
 generating DTMF tones 10-1
 Global Directory
 allowing system name to be displayed 6-8
 configuring to use 6-8
 copying to local system 6-9
 displaying 6-8
 displaying addresses 2-13
 Global Directory (GDS) (setting) 6-8
 Global Directory Server
 DNS name 6-8
 IP address 6-8
 password 6-8
 registering to 6-8
 Global Directory Servers (screen) 6-8
 Global Management System
 account number, requiring 9-5
 account number, validating 9-5
 description 9-4
 management servers list 9-4
 requesting support from administrator 9-6
 Global Services, configuring 9-4
 Graphics VGA (screen) 5-6
 graphics, *See* content
 Group Name (setting) 6-9

H

H.239, enabling 5-7
 H.239, *See also* sharing content
 H.320, *See* ISDN
 H.323
 enabling 2-27
 extension 2-4, 2-5, 2-8
 H.323 Extension (E.164) (setting) 2-4, 2-5, 2-8, 7-4
 H.323 Name (setting) 2-4, 2-5
 H.323 Settings (screen) 2-4, 2-5, 2-8
 H.323, *See also* IP
 H.331, *See* broadcast mode

- headphones 4-6
 - help
 - from GMS administrator 9-5
 - on-screen 7-6, 7-10
 - home screen
 - adding sites 7-6
 - customizing 7-3
 - settings 7-4
 - Home Screen Settings (screen) 7-4, 7-6
 - Horizontal Position (setting) 5-6
 - Host Name (setting) 2-2
- I**
- icons
 - camera 3-13, 3-14, 7-9
 - displaying 3-6
 - line status 12-9
 - low battery 12-24
 - ImageShare II
 - configuring 5-7
 - connecting 5-5
 - Import Directory (utility) 6-7
 - IMUX, *See* BRI network interface
 - Incoming Video Call (setting) 4-9
 - indicators
 - call progress 11-3, 12-9, 12-11
 - low battery icon 12-24
 - initial system configuration 1-6
 - Input Type (setting) 4-11, 4-15, 4-16
 - instructions, on-screen 7-6, 7-10, 9-4
 - internal CSU, output attenuation 2-22
 - internal ringer (VSX 3000) 4-9, 7-9, A-1
 - internal ringer (VSX 3000A) 4-9, 7-9
 - international access code, ISDN 7-1
 - International Dialing Prefix (setting) 2-22
 - interoperability issues, resolving 12-2
 - inverse multiplexer, *See* BRI network interface
 - IP
 - calls, enabling 2-27
 - connectivity tests 11-4
 - IP address
 - default gateway 2-3
 - displaying 7-5
 - DNS server 2-3
 - entering manually 2-2
 - gatekeeper 2-5
 - Global Directory Server 6-8
 - multicast 6-11
 - obtaining 2-2
 - primary gatekeeper 2-5
 - SIP proxy server 2-9
 - SIP registrar server 2-9
 - SNMP network management workstation 9-8
 - unicast, of streaming server 6-11
 - WINS server 2-3
 - IP Address (setting) 2-2
 - IP Multicast Address (setting) 6-11
 - IP network, configuring 2-4–2-13
 - IP or ISDN Information (setting) 7-5
 - IP precedence 2-11
 - IR sensors, connecting to VSX 8000 10-2
 - ISDN
 - BRI, configuring 2-19
 - calls, enabling 2-19, 2-21
 - channels dialed in parallel 2-19, 2-22
 - dialing prefix for outside line 2-21
 - enabling 2-27
 - line signaling protocol 2-21
 - network hardware requirements 2-15, 2-16
 - numbers, displaying 7-5
 - PRI, activating/deactivating channels 2-23
 - PRI, configuring 2-21, 2-22, 2-23
 - restore PRI defaults 2-22
 - SPIDs 2-20
 - switch protocol 2-20, 2-22
 - voice-only calls, enabling 2-28
 - ISDN (screen) 2-19, 2-21
 - ISDN International Access (setting) 7-1
 - ISDN Switch Protocol (setting) 2-20
 - ISDN Voice Algorithm (setting) 2-20, 2-22
- K**
- Keypad Audio Confirmation (setting) 10-1
 - kiosk mode 7-3, 8-5
 - kit
 - ceiling microphone 4-1
 - StereoSurround 4-7
- L**
- LAN
 - configuring 2-2
 - LAN Properties (screen) 2-2, 2-3

- LAN Speed (setting) 2-3
- Language (setting) 7-1
- Last Number Dialed (setting) 7-5
- Level (setting) 4-11, 4-12
- lighting
 - backlight compensation 3-12
 - brightness 3-12
- lights
 - BRI network interface 2-17
 - serial V.35/RS-449/RS-530 network interface 2-18
- Line Build Out (setting) 2-22
- Line Input (setting) 4-11, 4-12, 4-15, 4-16, 5-2, 5-7
- Line Out 2 Phono (setting) 4-11, 4-12
- Line Outputs (setting) 4-13
- Line Signaling (setting) 2-21
- line status icons 12-9
- Line Termination (read-only setting) 2-23
- LiveMusicMode
 - enabling 4-10
- Local Date and Time (setting) 7-5
- Localized Name (setting) 6-8
- localized system name 6-7
- Localized System Name (setting) 6-6
- Location (screen) 2-20, 7-1
- Location Name (setting) 9-8
- location settings 7-1, 7-2
- Lotus Notes 2-10
- Lotus Sametime 2-10
- low battery icon 12-24

M

- main camera, *See* cameras, primary
- Management Servers (screen) 9-4
- managing directories 6-7
- managing system profiles 9-3
- managing user access 7-3
- marquee text 7-6
- Master Audio Volume (setting) 4-13
- maximum call duration 6-1
- Maximum Receive Bandwidth (setting) 2-11
- Maximum Speed for Receiving Calls (setting) 2-29
- Maximum Time in Call (setting) 6-1
- Maximum Transmission Unit Size (setting) 2-11
- Maximum Transmit Bandwidth (setting) 2-11
- meeting password 8-2
- menu map 8-1

- messages
 - network congestion 12-8, 12-24
 - sending to call participants 9-4
- MIBs, downloading 9-7
- microphones
 - ceiling mount kit 4-1
 - configuring 4-9, 4-16
 - enabling 4-9
 - extension, for SoundStation VTX 1000 4-5
 - positioning 4-1
 - positioning for stereo 4-4, 4-7
 - powered 4-6
 - supported cable configurations 4-2, 5-4
 - troubleshooting 12-20
 - when disabled 4-9
- Microsoft LCS
 - displaying contacts on home screen 7-4
 - displaying contacts on the home screen 7-6
 - TCP transport protocol 2-9
- Midrange Speaker (setting) 4-13, 5-2
- mixed calls, allowing 6-1
- mixer, *See* Vortex mixer
- modem
 - configuring for closed captions 10-3
- Monitor 1 (setting) 3-2, 3-4
- Monitor 2 (setting) 3-3, 3-4
- Monitor Far-Site Audio (setting) 4-13
- monitors
 - aspect ratio, specifying 3-2, 3-3
 - brightness adjustment 3-9
 - burn-in prevention 3-9
 - color balance adjustment 3-10
 - configuring 3-2, 3-10
 - configuring content display 3-5
 - configuring for dual monitor emulation 3-7
 - screen saver output 3-2, 3-3
 - sharpness setting 3-9
 - specifying what to display 3-4
 - troubleshooting 12-5, 12-12
 - video
 - format, specifying 3-2
 - video format, specifying 3-3
 - VSX 3000 as computer monitor 3-1
 - VSX 3000A as computer monitor 3-1
- Monitors (screen) 3-2, 5-7
- Motion (setting) 3-13, 3-14
- mounting brackets, installing 1-4
- multicast IP address 6-11
- multicasting, *See* web streaming
- Multipoint (setting) 7-4

- answering automatically 3-8, 6-2, 6-3
 - button on home screen 7-4
 - cascaded 6-5
 - configuring 3-8
 - display mode 3-8
 - option key 6-4
 - trial mode 6-4
 - using PathNavigator 2-6, 6-4
 - Multipoint Mode (setting) 3-8
 - Multipoint Setup (screen) 3-8
 - Mute Auto-Answer Calls (setting) 4-9
 - My Contacts list 7-5
 - My Information (screen) 9-5, 9-6
 - My Information (setting) 7-5
- N**
- name
 - camera 3-13, 3-14, 7-9
 - DNS, system 2-2
 - H.323 2-4, 2-5
 - host 2-2
 - SIP 2-9
 - system, displaying 7-5
 - system, in Simplified Chinese 6-6, 6-7
 - system, setting 6-6
 - NAT
 - configuring 2-12, 2-13
 - Public (WAN) Address (setting) 2-13
 - UPnP certified 2-13
 - NAT Configuration (setting) 2-13
 - NAT is H.323 Compatible (setting) 2-13
 - near end loop test 11-4
 - network
 - configuring using the setup wizard 1-6
 - diagnostic tools 11-2
 - IP, configuring 2-4–2-13
 - preparing 2-1
 - Network Address Translation, *See* NAT
 - network congestion message 12-8, 12-24
 - network hardware requirements
 - for BRI 2-15, 2-16
 - for PRI 2-16
 - for serial V.35/RS-449/RS-530 2-16
 - network interfaces
 - available for VSX systems 2-15
 - BRI 2-15, 2-16
 - BRI, configuring 2-19, 2-20
 - BRI, lights 2-17
 - connecting 2-15, 2-17
 - PRI 2-15, 2-17
 - PRI, configuring 2-21
 - serial V.35/RS-449/RS-530 2-15, 2-17, 2-24, 2-25, 2-28
 - serial V.35/RS-449/RS-530, lights 2-18
 - Network Mode (read-only setting) 2-23
 - news feed screen saver 7-10
 - Nortel Multimedia Communication Server (MCS) 2-9
 - null modem adapter 5-10
 - Number (setting), gateway 2-8
 - Number + Extension (setting) 2-8
 - Number of Active Channels (read-only setting) 2-23
 - Number of Digits in DID Number (setting) 2-8
 - Number of Digits in Extension (setting) 2-8
 - Number of ISDN Channels to Dial in Parallel (setting) 2-19, 2-22
 - Number of Router Hops (setting) 6-10
 - Numbering Plan (setting) 2-19, 2-22
- O**
- Obtain IP Address Automatically (setting) 2-2
 - on-screen instructions, providing 7-6, 7-10, 9-4
 - option key
 - multipoint 6-4
 - options
 - multipoint calling 6-4
 - multipoint trial mode 6-4
 - People+Content IP 5-1
 - Options (screen) 6-4
 - Output upon Screen Saver Activation (setting) 3-2, 3-3
 - Outside Line Dialing Prefix (setting) 2-19, 2-21, 2-26
 - overlay
 - video 7-8
- P**
- packet loss, in Call Statistics 11-3

- passwords
 - Global Directory 6-8
 - meeting, setting 8-2
 - remote access 8-4
 - remote access, setting and deleting 8-2
 - room, default 1-6, 8-4
 - room, setting and deleting 1-6, 8-2, 8-4
 - Security Mode requirements 8-6
 - SIP authentication 2-9
 - PathNavigator, using for multipoint calls 2-6, 6-4
 - PBX, unaccepted calls 12-10
 - PCAS
 - Lotus Sametime or Lotus Notes 2-10
 - PCAS (setting) 2-10
 - PCAS Server Address (setting) 2-10
 - People+Content
 - enabling for H.331 broadcasting 2-25
 - enabling H.239 5-7
 - People+Content IP
 - enabling 5-8
 - installing on a computer 5-8
 - option 5-1
 - requirements 5-7
 - supported resolutions 5-7
 - Phase (setting) 5-6
 - picture-in-picture, *See* PIP
 - PIP
 - configuring 3-5
 - displaying 3-5
 - troubleshooting 12-13, 12-16
 - Place a Call (screen), *See* home screen
 - placing test calls 12-1
 - plasma monitors and burn-in prevention 3-9
 - Polycom Annotation RS-232 mode 10-3
 - ports
 - fixed, specifying 2-12
 - serial V.35/RS-449/RS-530 2-23
 - SIP proxy server 2-9
 - SIP registrar server 2-9
 - TCP and UDP, specifying 2-12
 - positioning
 - camera 1-2
 - microphones 4-1
 - microphones, for stereo 4-4, 4-7
 - monitors 1-2
 - SoundStation VTX 1000 4-1
 - SoundStation VTX 1000, for stereo 4-5
 - speakers, for stereo 4-7
 - subwoofer 4-8
 - system 1-2, 1-4
 - POTS, *See* analog phone
 - power
 - resetting system 11-5
 - Power Frequency (setting) 3-12
 - power switch 1-6
 - powered microphones
 - configuring 4-11, 4-16
 - connected to VSX 8000 4-6
 - used with audio mixer 4-6
 - Preferred Dialing Method (setting) 2-28
 - Preferred Speed for Placing Calls (setting) 2-29
 - Preferred Speeds (screen) 2-29
 - prefix, gateway 2-8
 - Presentation mode (multipoint display) 3-8
 - presets, *See* camera presets
 - PRI Line Type (read-only setting) 2-23
 - PRI network interface
 - activating/deactivating channels 2-23
 - capabilities 2-15
 - configuring 2-21, 2-22, 2-23
 - connecting to set-top and component systems 2-17
 - hardware requirements 2-17
 - line signaling formats 2-21
 - restore defaults 2-22
 - PRI Video Number (setting) 2-21
 - Primary Camera (setting) 3-12
 - Primary Gatekeeper IP Address (setting) 2-5
 - profiles
 - managing with the system's web interface 9-3
 - settings that are included 9-3
 - storing on a computer 9-3
 - uploading from a computer 9-3
 - projector
 - connected to Visual Concert VSX 5-3
 - Pro-Motion Video (setting) 3-13
 - Pro-Motion, specifying when to use 3-13
 - protocol
 - ISDN line signaling 2-21
 - ISDN switch 2-20, 2-22
 - transport, for SIP network 2-9
 - Proxy Server (setting) 2-9
 - Pulse Width (setting) 2-25
 - PVEC (Polycom Video Error Concealment) 2-11
- Q**
- Quality of Service (screen) 2-10, 2-11
 - Quality Preference (setting) 5-6
- R**
- rack mounting brackets, installing 1-4

- RAS200I
 - Lotus Sametime or Lotus Notes 2-10
 - rear panel view
 - VSX 3000A A-1
 - VSX 5000 A-2
 - VSX 6000 A-3
 - VSX 6000A A-4
 - VSX 7000 A-5, A-6
 - VSX 7000e A-7
 - VSX 7000s A-6
 - VSX 8000 A-8
 - Recent Calls
 - accessing with the remote control 10-1
 - button on home screen 6-2, 7-5
 - calls not listed 11-6
 - list 6-2, 11-6
 - recent calls
 - See also* Call Detail Report (CDR)
 - recording calls
 - configuring audio 5-2, 5-3
 - configuring video source 3-5
 - setting volume 4-12, 4-13
 - troubleshooting 12-13
 - while playing a VCR/DVD 4-10, 4-12, 4-13
 - refusing calls 6-3, 7-5
 - registering with Global Directory Server 6-8
 - Registrar Server (setting) 2-9
 - remote access
 - enabling 8-3
 - password 8-4
 - remote access password 8-4
 - Remote Access Password (setting) 8-2
 - remote control
 - configuring 10-1
 - keypad audio confirmation 10-1
 - troubleshooting 12-5
 - Remote Control (screen) 10-1
 - Remote Control Keypad (setting) 10-1
 - remote management 8-3
 - requirements
 - browser, for the system's web interface 9-1
 - for People+Content IP 5-7
 - for updating software 9-8
 - for using PathNavigator Conference On Demand 2-6
 - hardware, for BRI network 2-15, 2-16
 - hardware, for PRI network 2-16
 - hardware, for serial V.35/RS-449/RS-530 network 2-16
 - software, for SoundStation VTX 1000 4-4
 - software, for viewing web streams 6-11
 - software, for Vortex mixer 4-6
 - reset system 11-5
 - Reset System (screen) 8-4
 - resolution, VGA
 - for People+Content IP 5-7
 - for Visual Concert VSX 5-3
 - specifying, for Visual Concert VSX or ImageShare II 5-6
 - restart system
 - actions that cause 2-2, 2-3, 8-3
 - diagnostic tool 11-5
 - Restore Defaults (setting) 2-22
 - ring tones
 - setting 4-9, 7-9
 - volume 4-9
 - VSX 3000 4-9, 7-9, A-1
 - VSX 3000A 4-9, 7-9
 - ringer, internal (VSX 3000) 4-9, 7-9, A-1
 - ringer, internal (VSX 3000A) 4-9, 7-9
 - room layouts for stereo 4-4, 4-5, 4-14
 - room monitoring
 - enabling 8-3, 9-2
 - viewing a room or call 9-2
 - room password
 - default 1-6, 8-4
 - screens that require 8-1
 - setting and deleting 1-6, 8-2, 8-4
 - Room Telephone Number (setting) 2-26, 7-1
 - RS-232 Mode (setting) 3-14, 4-15, 10-3
 - RS-232 serial port
 - configuring for a Vortex mixer 4-15
 - configuring for closed captions 5-10
 - configuring to provide Telnet trace 10-3
 - data pass-through 10-3
 - equipment used with 10-2
 - RS-366 Dialing (setting) 2-23
 - RS-449, *See* serial V.35/RS-449/RS-530
 - RS-530, *See* serial V.35/RS-449/RS-530
 - RSVP (Resource Reservation Setup Protocol) 2-11
 - RT signal polarity 2-24
 - RTS signal polarity 2-24
- S**
- Save Global Directory to System (setting) 6-9
 - screen saver
 - displaying a news feed 7-10
 - text 7-10
 - Screen Saver (screen) 7-10, 7-11
 - screen saver output
 - monitor 1 3-2
 - monitor 2 3-3

- screens
 - diagram of system 8-1
- security
 - allowing mixed calls 6-1
 - controlling remote access 8-3, 9-2
 - home screen settings 7-4
 - room monitoring 9-2
 - Security Mode setting 8-6
 - System screen access 7-4
 - systems outside firewalls 2-13
- Security (screen) 8-2, 8-4, 8-5, 8-8, 9-2
- Security Mode
 - enabling 8-6
 - limitations 8-6
- Security Mode (setting) 8-2
- Send a Message (screen, system's web interface) 9-4
- Send Content When PC Connects (setting) 5-6
- sensor, IR 10-2
- serial dialing 2-22
- Serial Port (screen) 5-10, 10-3
- serial port, *See also* RS-232 serial port
- serial V.35/RS-449/RS-530 network interface
 - call speed 2-24
 - calling profile 2-24
 - configuring 2-24, 2-25
 - configuring signal polarity 2-24
 - connecting 2-15, 2-17
 - crypto resync pulse 2-25
 - enabling 2-28
 - hardware requirements 2-17
 - lights 2-18
- servers
 - DNS 2-3
 - streaming 6-11
 - WINS 2-3
- setup wizard 1-6
- sharing content
 - by connecting a computer to a VSX system 5-5
 - configuring audio 5-7
 - configuring display 5-6, 5-7
 - enabling H.239 2-27
 - specifying when to display 5-6
 - using ImageShare II 5-5
 - using People+Content IP 5-7
 - using Visual Concert VSX 5-3
- Sharpness (setting) 3-13, 3-14
- signal polarity
 - CTS 2-24
 - DCD 2-24
 - DSR 2-24
 - DTR 2-24
 - RT 2-24
 - RTS 2-24
 - ST 2-24
- SIP
 - authentication name 2-9
 - configuring 2-9
 - enabling 2-27
 - Lotus Sametime or Lotus Notes 2-10
 - password 2-9
 - proxy server 2-9
 - registrar server 2-9
 - restrictions 2-10
 - transport protocol 2-9
 - user name 2-9
- SIP Settings (screen) 2-9
- site buttons, adding 7-6
- Sites (screen) 7-6
- Sites (setting) 7-5
- siting considerations 1-2, 4-1
- Snap Button Option (setting) 10-1
- Snapshot Timeout (setting) 3-6
- SNMP
 - access, controlling 8-3
 - conditions reported 9-6
 - configuring 9-7
 - downloading and installing MIB 9-7
- SNMP (screen) 9-7
- Softupdate 9-8
- software registration key
 - People+Content IP 5-8
- software, updating 9-8
- Sound Effects Volume (setting) 4-9
- SoundStation VTX 1000
 - positioning 4-1
 - positioning for stereo 4-5
 - software required 4-4
 - telephone number 2-26
 - troubleshooting 12-23
- Soundstation VTX 1000 operation 4-1
- speakerphone, *See* SoundStation VTX 1000

- speakers
 - configuring 4-13
 - desktop, for VSX 3000A 4-6
 - positioning for stereo 4-7
 - required for StereoSurround 4-7
 - subwoofer 4-13
 - systems that include 4-6
 - systems that require 4-6, 4-7
 - troubleshooting 12-19, 12-21
 - Specify with PIN (gatekeeper setting) 2-5
 - Speed (setting) 2-24, 6-10
 - speed dial 7-5, 7-6
 - speed, call statistics 11-3
 - SPIDs
 - automatic configuration 2-20
 - entering manually 2-20
 - ST signal polarity 2-24
 - stabilizer feet, installing 1-4
 - status
 - call 11-3
 - network and call diagnostic tools 11-2
 - system 11-2
 - StereoSurround
 - adjusting volume 4-15
 - configuring 4-14
 - enabling 4-10
 - hardware required for listening 4-7
 - microphone operation 4-1
 - positioning microphones 4-4, 4-7
 - positioning speakers 4-7
 - SoundStation VTX 1000 operation 4-1, 4-5
 - testing 4-14
 - troubleshooting 12-22, 12-23
 - StereoSurround kit 4-7
 - Streaming (screen) 6-10
 - streaming, *See also* web streaming
 - Subnet Mask (setting) 2-3
 - subwoofer
 - configuring 4-13
 - positioning 4-8
 - setting volume 4-13
 - Subwoofer Level (setting) 4-13
 - Subwoofer Speaker (setting) 4-13, 4-14
 - suffix, gateway 2-8
 - Switch Protocol (setting) 2-22
 - switch protocol, ISDN 2-20
 - switch, power 1-6
 - system
 - configuration, initial 1-6
 - name 2-4, 2-5
 - name, displaying 7-5
 - name, displaying in Simplified Chinese 6-6, 6-7
 - positioning 1-4
 - System (setting) 7-4
 - System Description (setting) 9-8
 - System Info, accessing with the remote control 10-1
 - System Name (setting) 6-6, 7-5
 - System Phone Number (setting) 2-26
 - system profiles
 - managing with the system's web interface 9-3
 - settings that are included 9-3
 - storing on a computer 9-3
 - uploading from a computer 9-3
 - System screen, allowing access 7-4
 - system's web interface
 - accessing 9-2
 - accessing diagnostic screens 11-2
 - accessing in Security Mode 8-6
 - Call Detail Report, downloading 11-7
 - managing directories 6-7
 - managing system profiles 9-3
 - providing closed captions 5-11
 - restrictions 9-2
 - room monitoring 8-3, 9-2
 - sending messages to call participants 9-4
- ## T
- Table Style (setting) 4-14
 - TCP Ports (setting) 2-12
 - technical support
 - contacting 12-25
 - from GMS administrator 9-5, 9-6
 - web page address 12-25
 - Telephony (screen) 2-26
 - telephony, configuring 2-26
 - Telnet
 - access, controlling 8-3
 - trace, configuring system to provide 10-3
 - using in Security Mode 8-6
 - using to provide closed captions 5-12
 - Terminal Endpoint ID (read-only setting) 2-23
 - test calls 12-1
 - test calls, stereo 4-15
 - tests
 - audio meter 11-5
 - color bar 3-10, 11-4
 - near end loop 11-4
 - speaker test 11-5

the system's web interface
 configuring browser 9-1

time

 daylight saving 7-2
 displaying 7-5
 elapsed, displaying 6-2, 7-2
 setting 7-1
 to display far site name 6-2
 zone 7-2

Time Between Pulses (setting) 2-25

Time Difference from GMT (setting) 7-2

Time Format (setting) 7-2

Time Server (setting) 7-2

time-out

 content display 3-6

tones

 alert 4-9, 7-9
 DTMF, generating 10-1
 internal ringer (VSX 3000) 4-9, 7-9, A-1
 internal ringer (VSX 3000A) 4-9, 7-9
 ring 4-9, 7-9

touch-panel control 10-2

 configuring 10-3
 troubleshooting 12-6

tracking calls 9-5

Transport Protocol (setting) 2-9

treble adjustment 4-13

troubleshooting

 test calls 12-1

Type of Service (setting) 2-11

Type of Service Value (setting) 2-11

U

UDP Ports (setting) 2-12

updating software 9-8

Use Gatekeeper (setting) 2-5

Use PathNavigator for Multipoint Calls (setting)
 2-6

Use Room Password for Remote Access (setting)
 8-2

Use RTS Signal for Resync Pulse (setting) 2-25

Use the Following IP Address (setting) 2-2

User Alert Tones (setting) 4-9

User Name, SIP 2-9

user settings

 allowing access 8-3
 auto-answer 6-3
 backlight compensation 3-12
 camera presets 3-16
 far control of near camera 3-12
 list 8-5
 muting auto-answer calls 4-9
 PIP 3-5

User Settings (screen), allowing access 8-3

User Settings button 8-5

utilities

 Call Detail Report 11-7
 Import Directory 6-7
 Web Director (room monitoring) 9-2
 web streaming 6-11

V

V.35 Ports Used (setting) 2-23

V.35/RS-449/RS-530 (screen) 2-23

V.35/RS-449/RS-530, *See also* serial V.35/RS-
 449/RS-530

VCR Far and Near Audio (setting) 4-13, 5-3

VCR format (setting) 3-5

VCR Record Source (setting) 3-5, 5-2

VCR/DVD

 configuring audio 5-2, 5-3
 troubleshooting 12-13, 12-15, 12-21

VCR/DVD Audio Out Always On (setting) 3-12,
 4-10, 4-12, 4-13

VCR/DVD In Level (setting) 4-10, 4-12

VCR/DVD Out Level (setting) 4-10, 4-12, 4-13

Vertical Position (setting) 5-6

VGA Input (screen) 5-6

VGA monitors

 connected to Visual Concert VSX 5-3

VGA Out (setting) 3-5

VGA Output with No Graphics (setting) 5-6

VGA resolution

 for People+Content IP 5-7
 for Visual Concert VSX 5-3

VGA Resolution (setting) 5-6

- video
 - brightness adjustment 3-9
 - color balance adjustment 3-10
 - error concealment 2-11
 - format, monitor 1 3-2
 - format, monitor 2 3-3
 - Motion setting 3-13, 3-14
 - port, web streaming 6-11
 - sharpness adjustment 3-9
 - sharpness setting 3-13, 3-14
 - specifying bandwidth for People and Content 5-6
 - specifying what monitors display 3-4
 - Video Format (setting), for broadcasting 2-25
 - video overlay 7-8
 - Video Port (setting) 6-11
 - Video Protocol (setting), for broadcasting 2-25
 - Video Quality (screen) 3-13, 3-14
 - Visual Concert VGA Out (setting) 3-5
 - Visual Concert VSX
 - as a LAN hub 5-3
 - configuring 5-7
 - supported cable configurations 5-4
 - valid hardware configurations 5-5
 - VGA resolution 5-3
 - Visual Concert VSX cable, *See* conference link cable
 - voice algorithm for ISDN 2-20, 2-22
 - voice tracking, *See* automatic camera tracking
 - voice-activated switching mode (multipoint display) 3-8
 - voice-mail menu navigation, *See* Remote Control Keypad (setting)
 - voice-only calls, enabling 2-28
 - volume
 - adjusting 12-20
 - alert tones 12-20
 - audio line in 4-11
 - bass 4-13
 - for recording calls 4-10, 4-12, 4-13
 - master control 4-13
 - sound effects 4-9, 12-20
 - subwoofer 4-13
 - treble 4-13
 - troubleshooting 12-20
 - VCR/DVD playback 4-10, 4-11, 4-12
 - Vortex mixer
 - configuring 4-15, 10-3
 - not compatible with echo cancellation 4-11
 - software requirements 4-6
 - VPN, configuring 2-13
 - VSX component systems 1-1
 - VSX desktop systems 1-1
 - VSX set-top systems 1-1
 - VSX to VTX cable (lengths and part numbers) 5-5
 - VTX Telephone Number (setting) 2-26
- ## W
- Web Access Port (setting) 8-3
 - web access, controlling 8-3
 - web browser, configuring to use the system's web interface 9-1
 - Web Director 8-3, 9-2
 - web streaming
 - configuring 6-10
 - restrictions 6-10
 - starting and stopping 6-11
 - troubleshooting 12-12
 - viewing 6-11
 - wide-screen monitors, configuring 3-2, 3-3, 3-6
 - WINS Resolution (setting) 2-3
 - WINS Server (setting) 2-3
- ## Z
- Zoom Video to Fit Screen (setting) 3-6